

# serie range

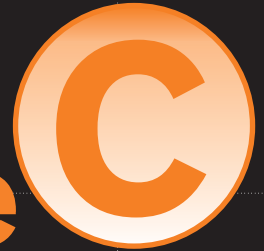

0'-3,49"



**Juntas y perfiles flexibles: tipo Varios**  
**Flexible Joints & Profiles: Other type**

**Materiales: caucho termoplástico, PVC, EPDM, neopreno, silicona...**  
**Materials: thermoplastic rubber, PVC, EPDM, neoprene, silicone...**

**Todos los dibujos a escala 1:1**  
**All drawings are to scale 1:1**





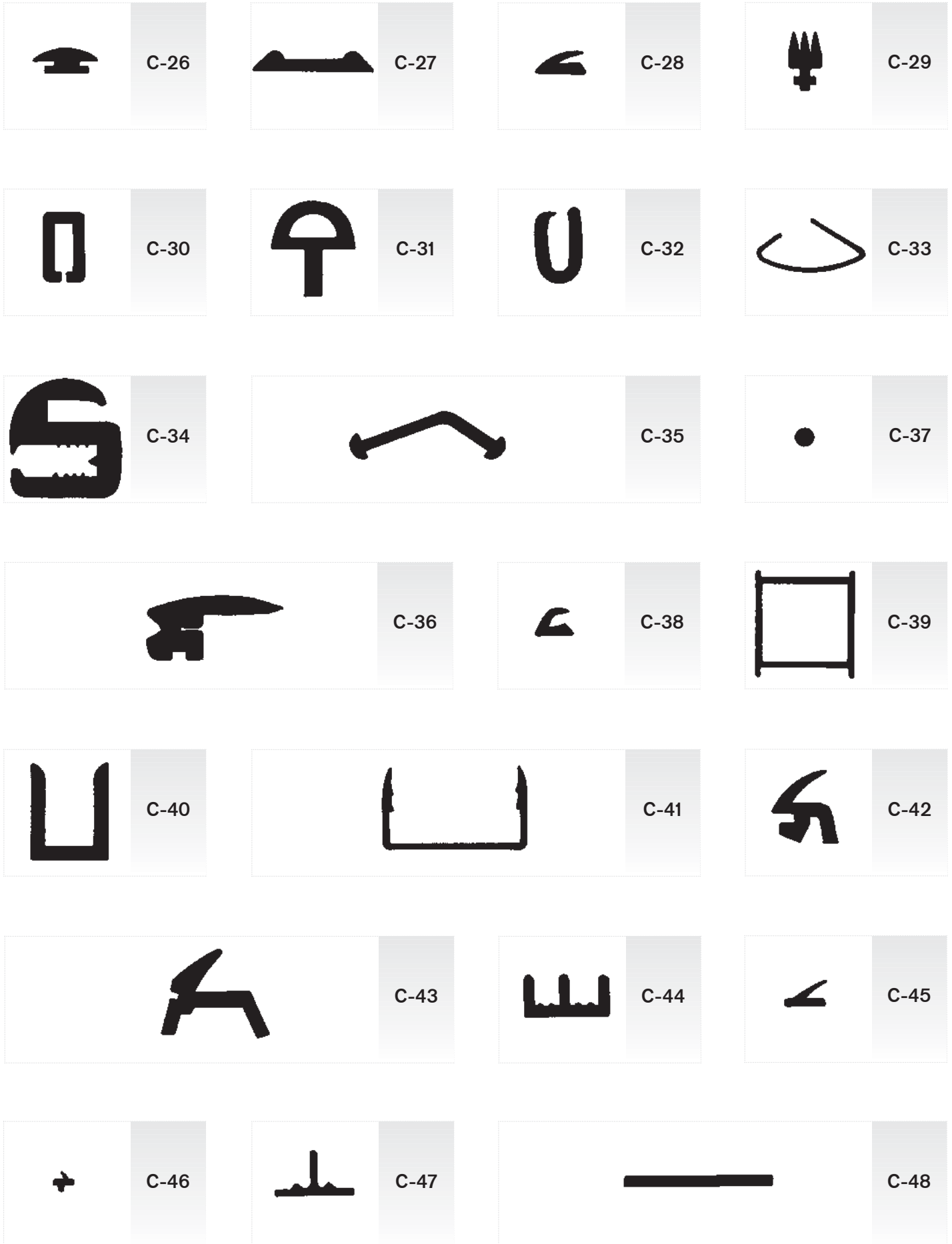

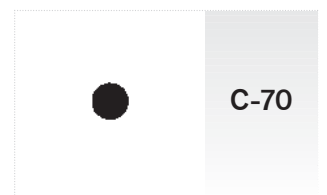
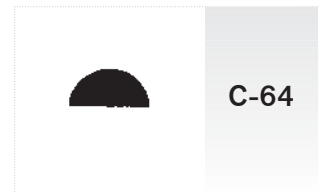
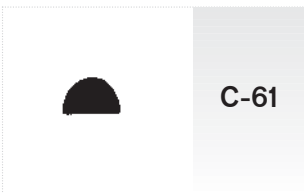
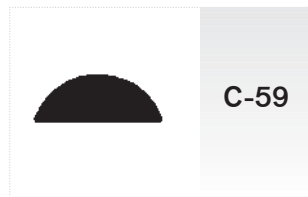
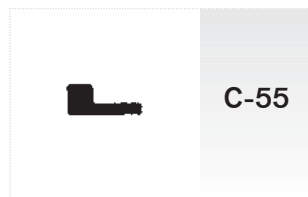
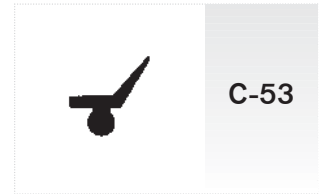
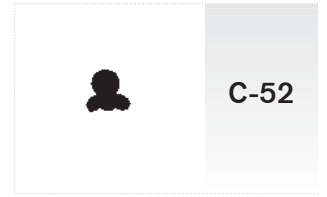
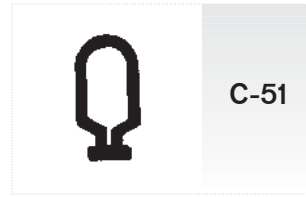

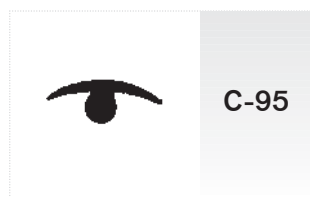
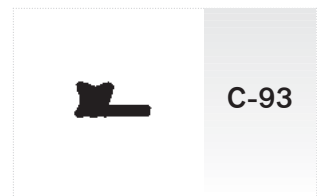
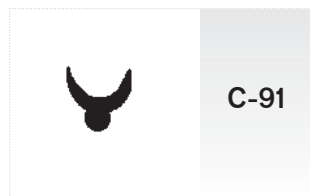
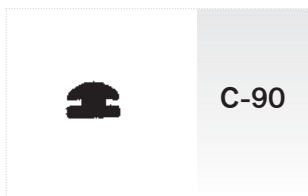
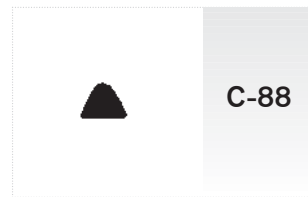
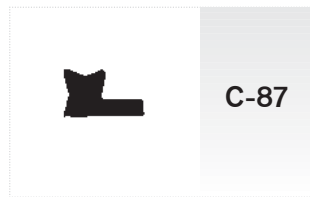
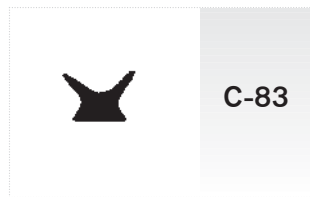
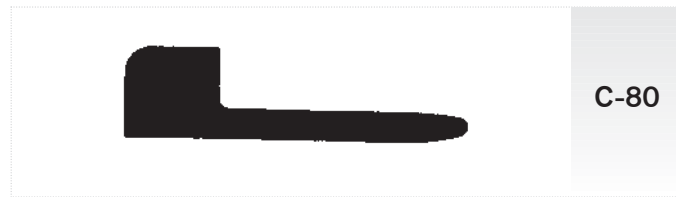
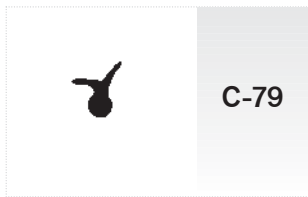
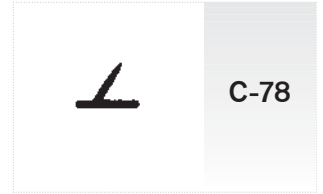
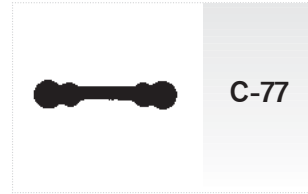
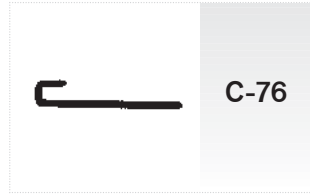
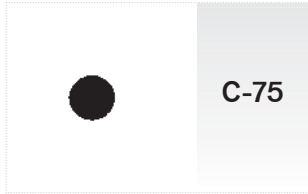
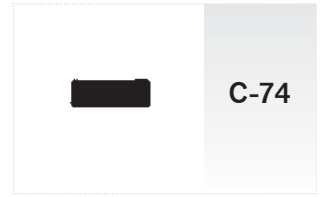
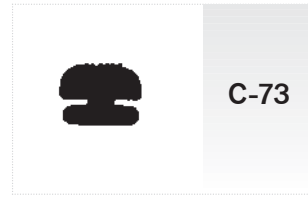
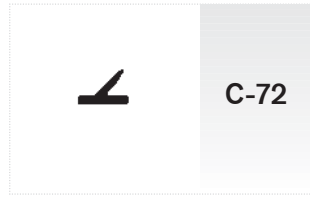
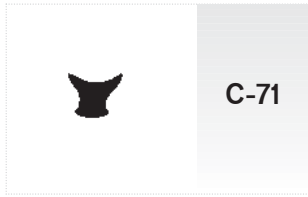

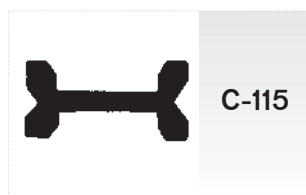
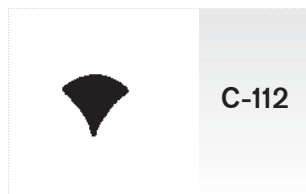
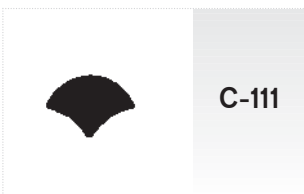
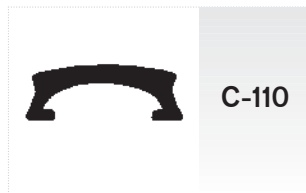
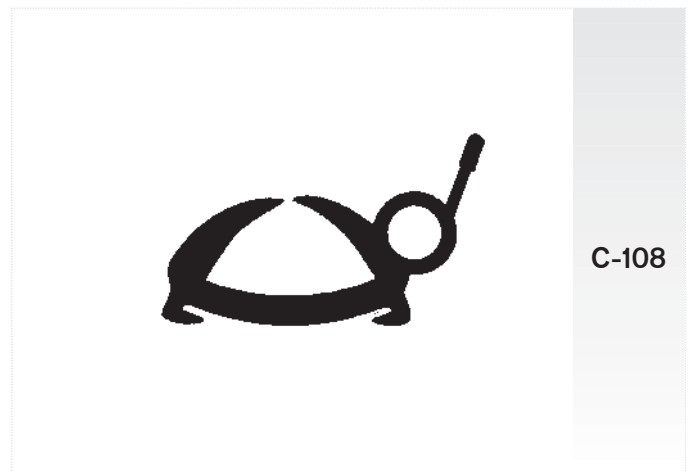
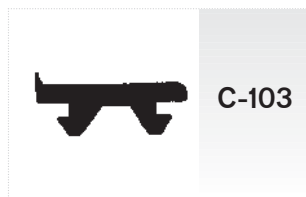
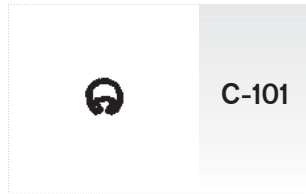
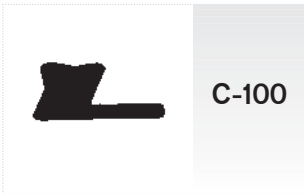
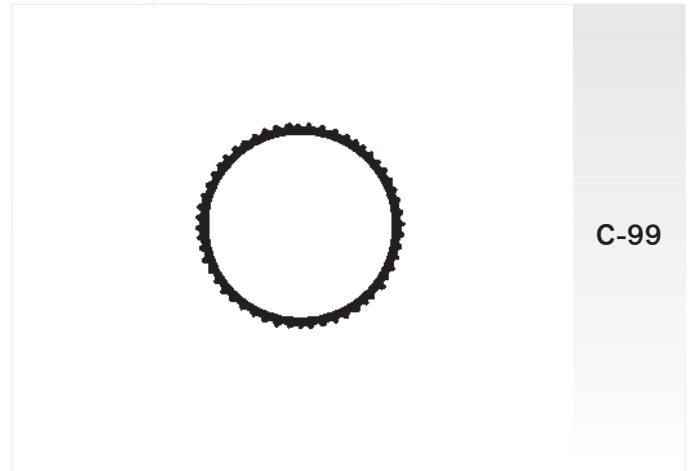
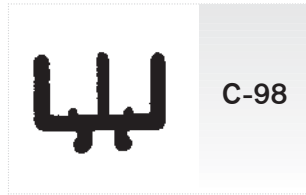
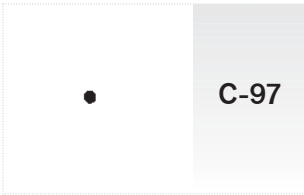

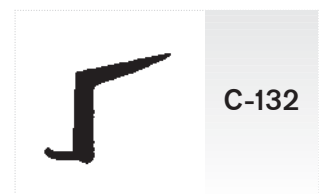
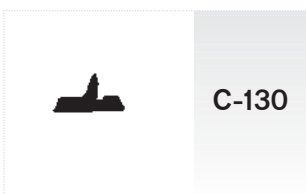
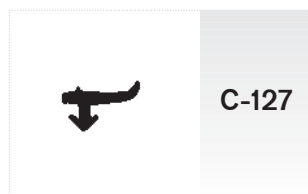
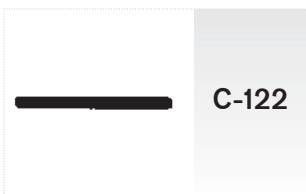
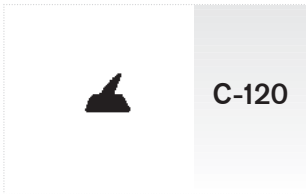
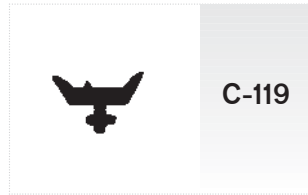
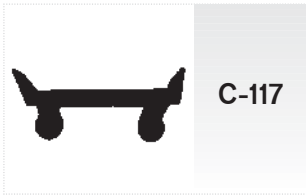

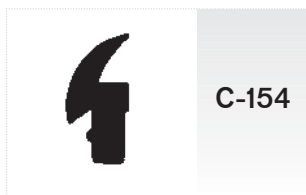
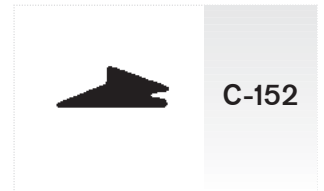
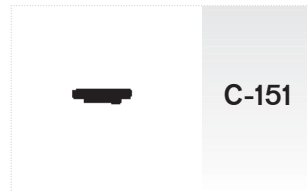
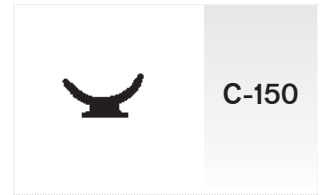
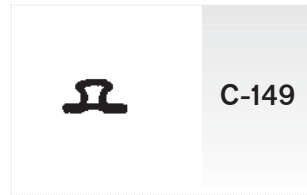
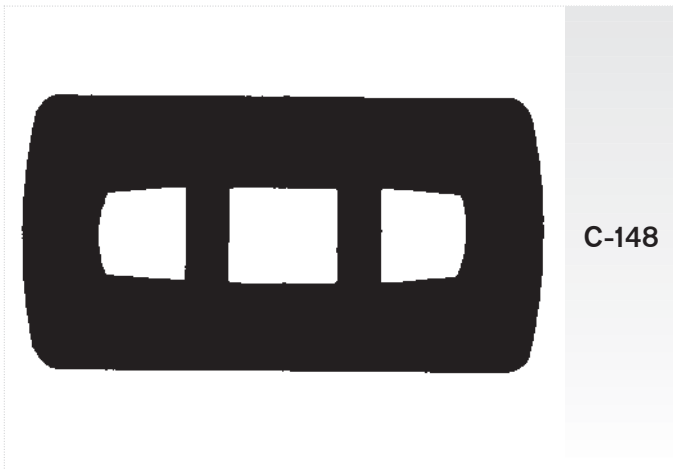
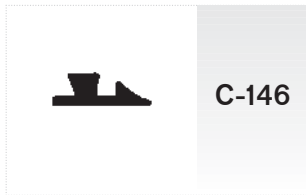
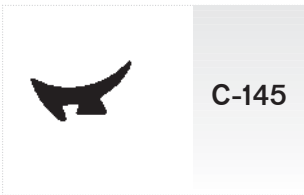
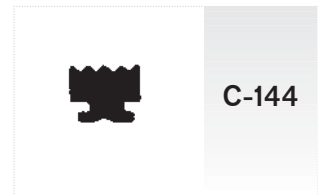
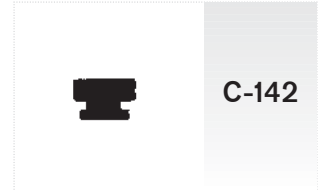
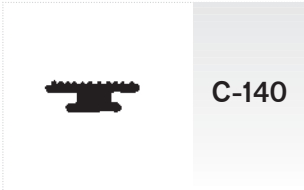
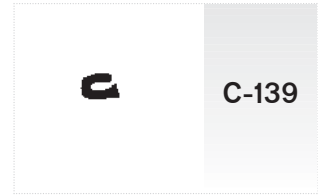
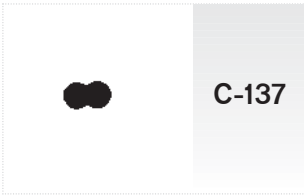



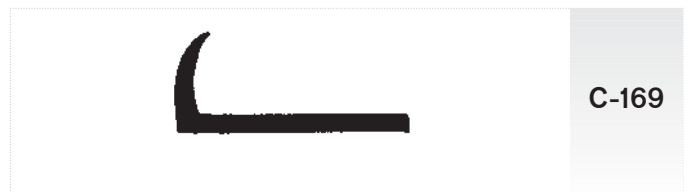
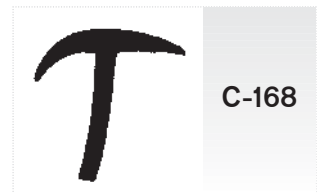
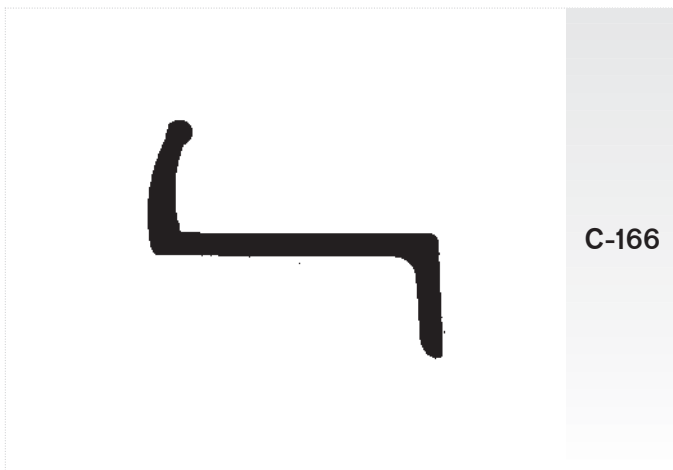
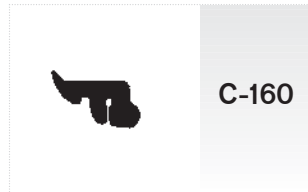
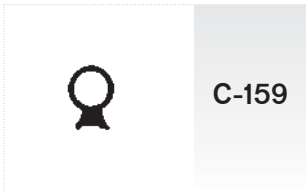
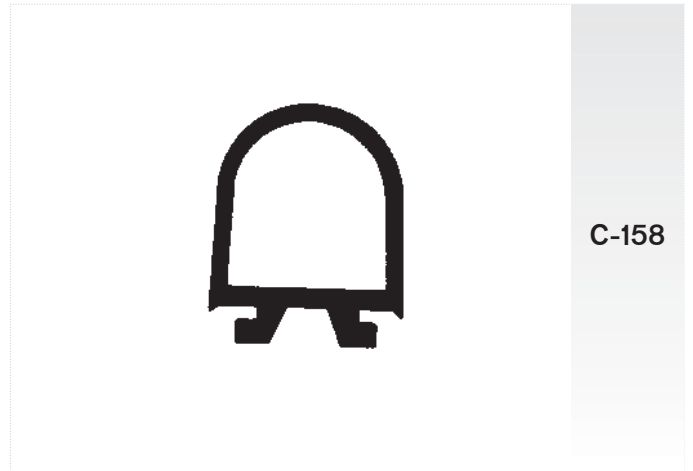
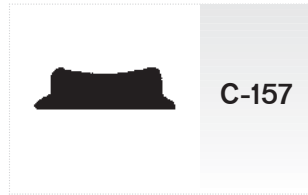
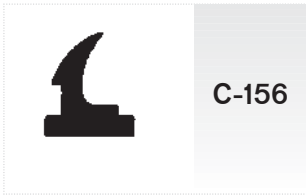

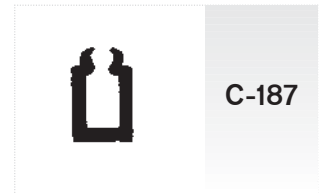
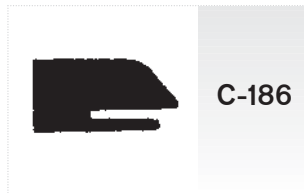
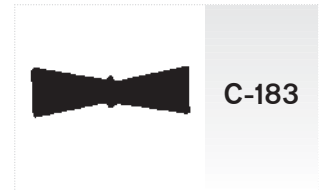
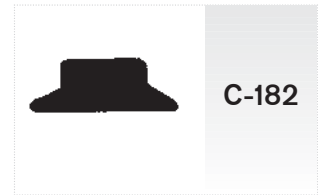
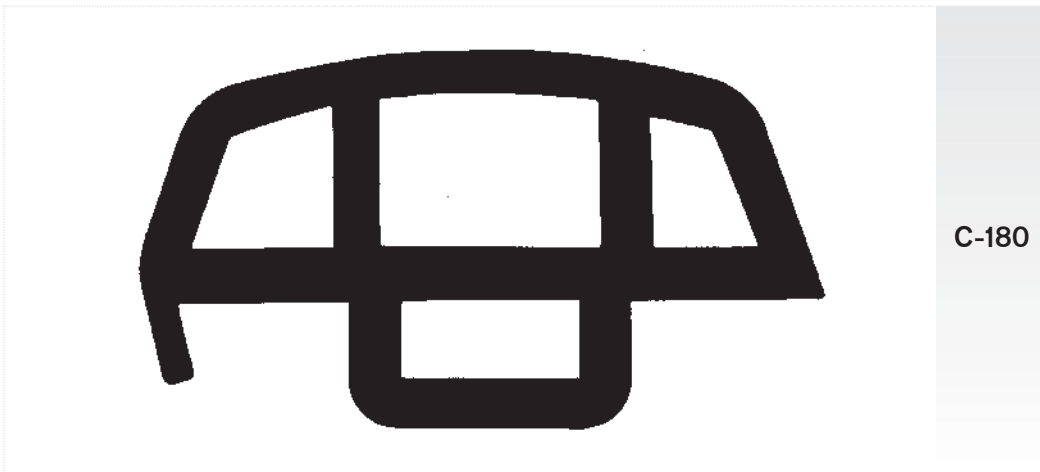
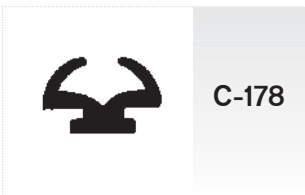
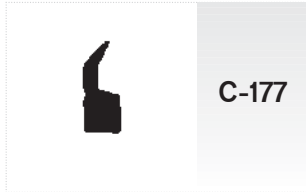
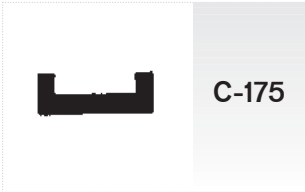
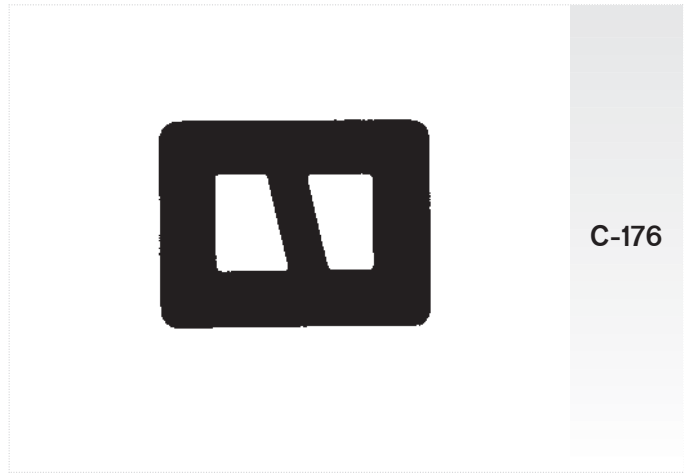
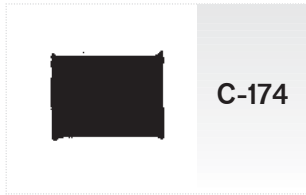

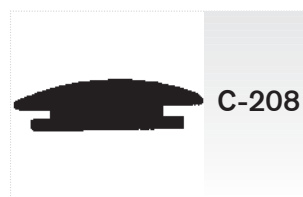
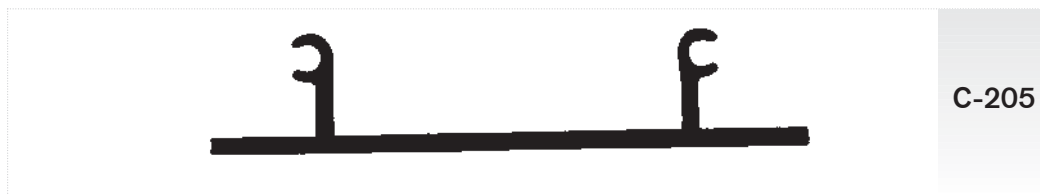
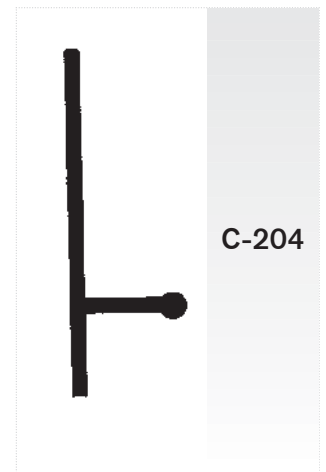
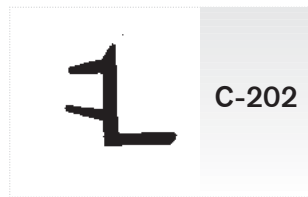
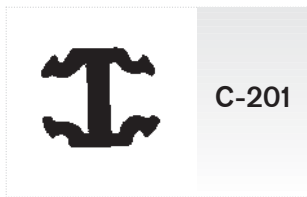
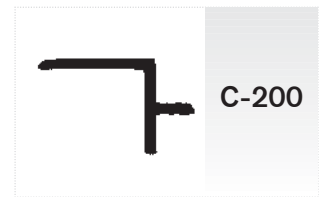
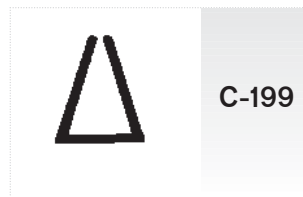
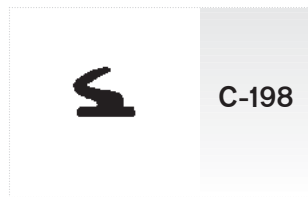
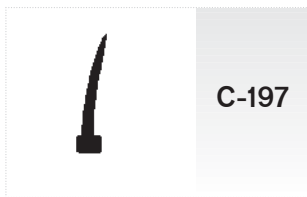
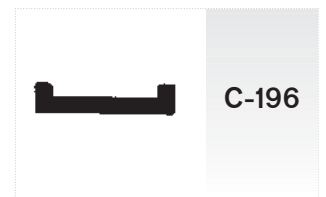
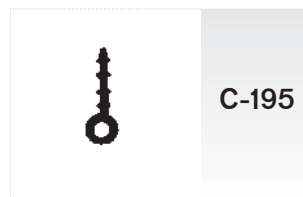
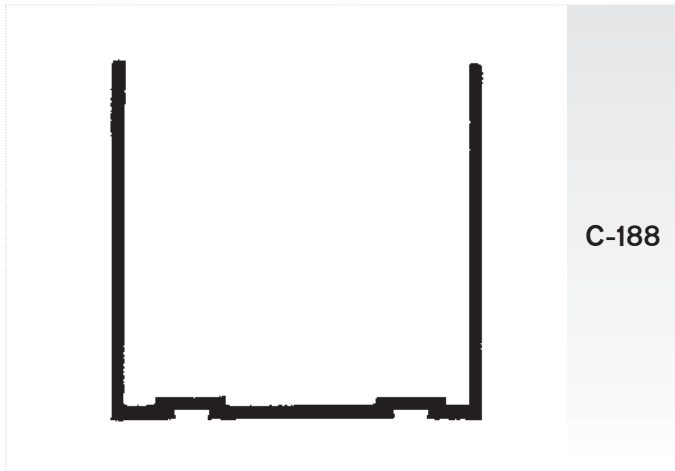

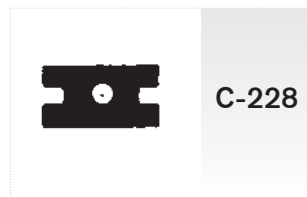
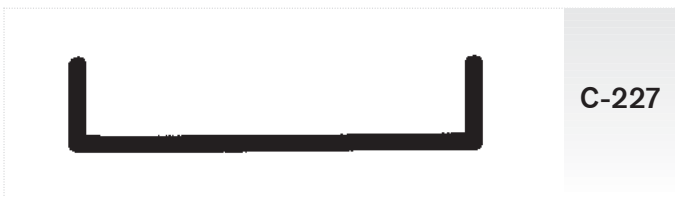
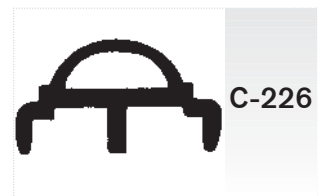
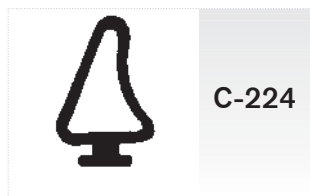
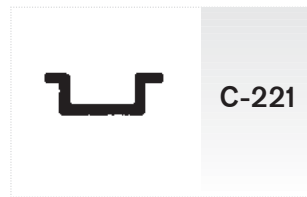
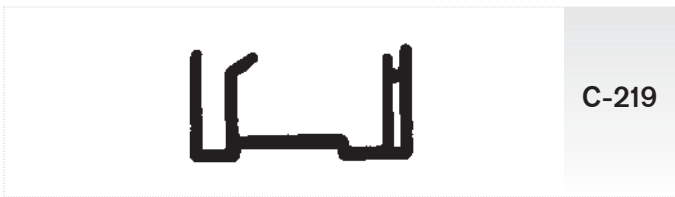
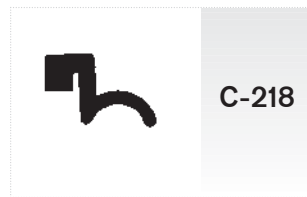
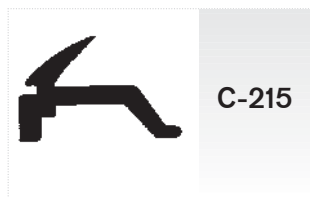
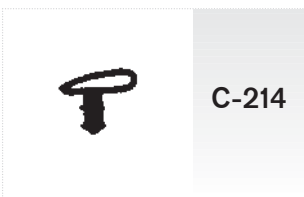
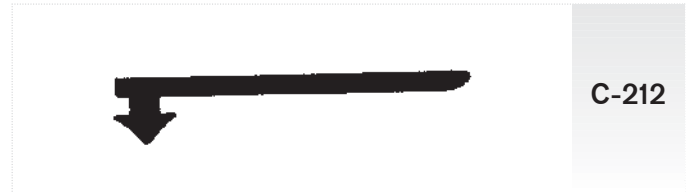
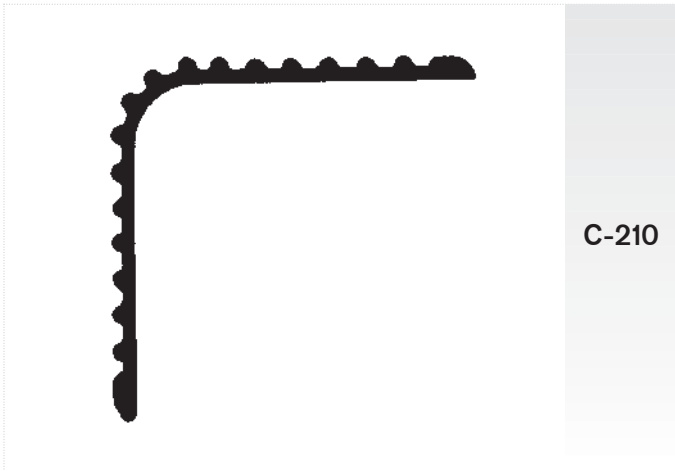

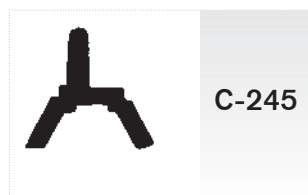
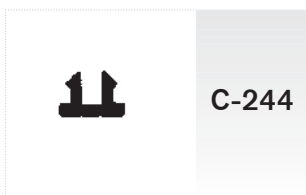
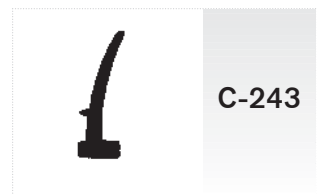
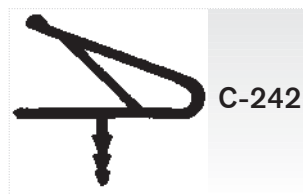
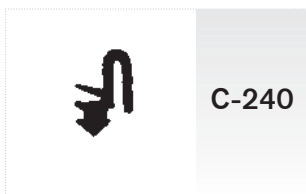
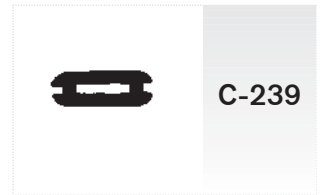
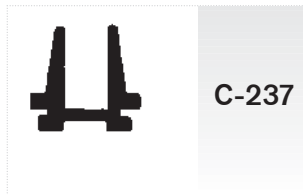
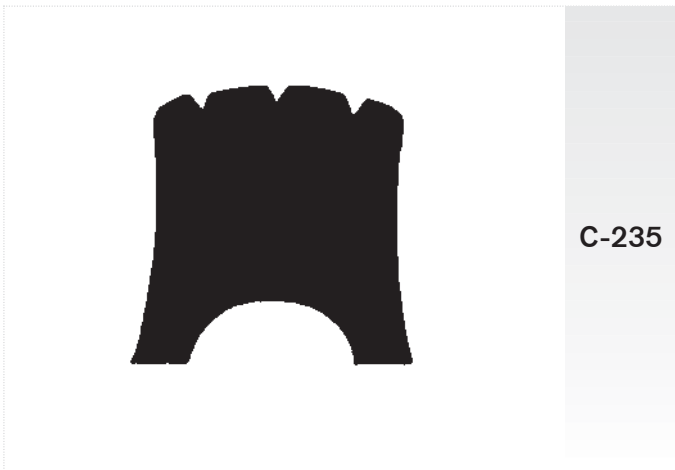
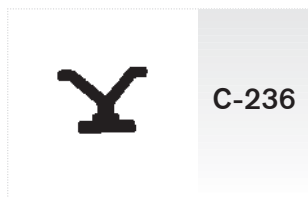
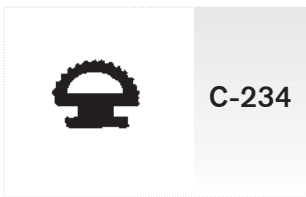
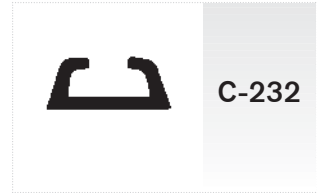

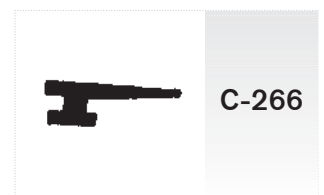
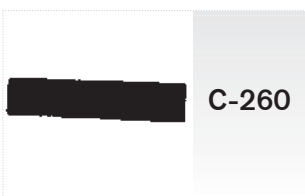
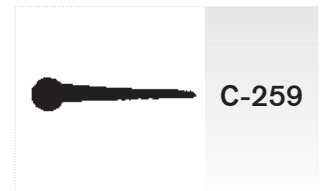
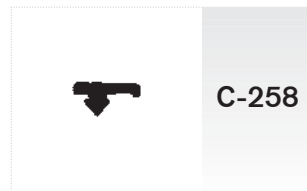
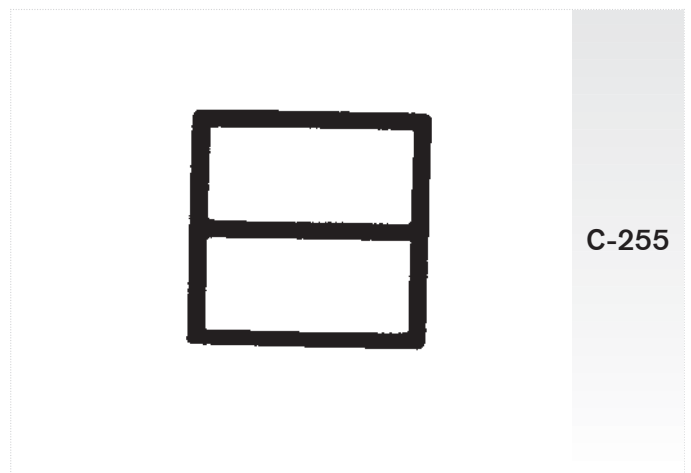
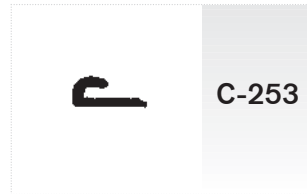
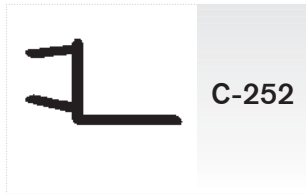
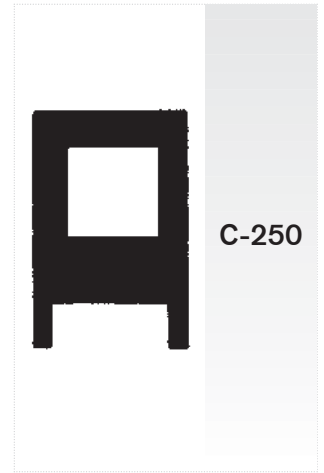
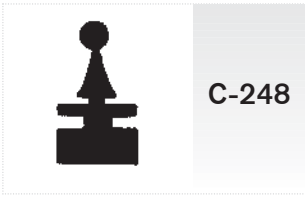

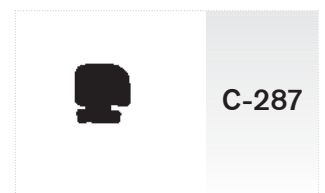
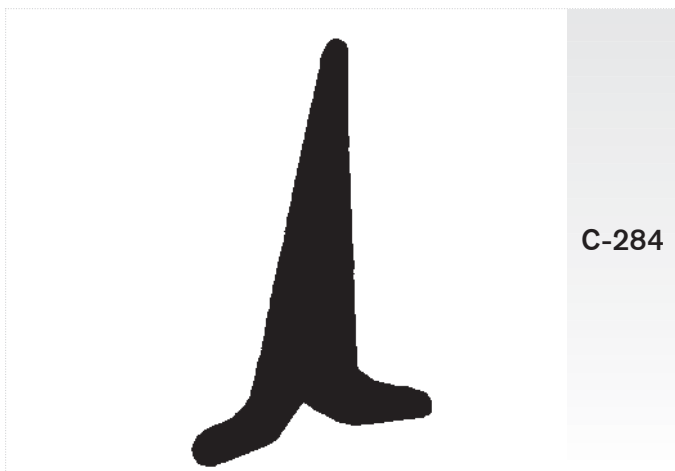
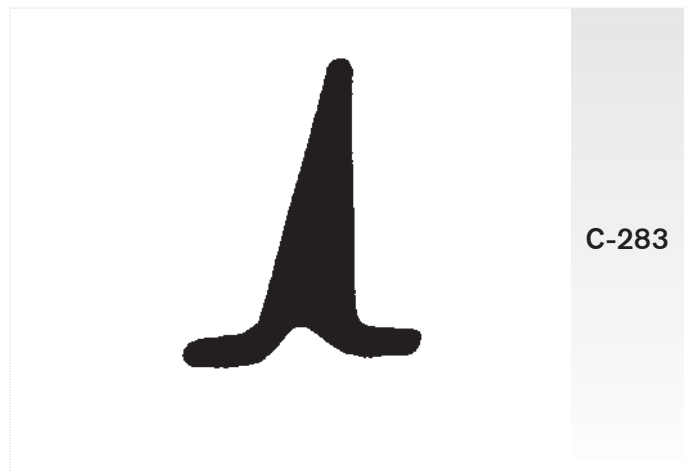
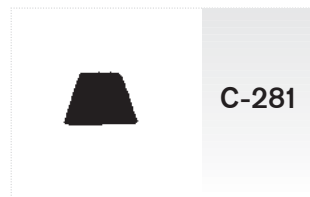
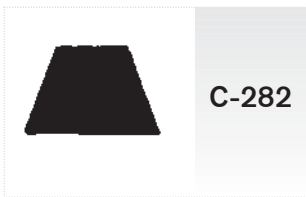
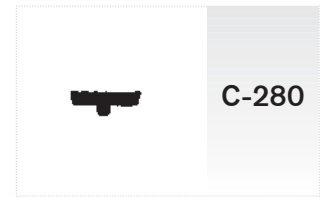
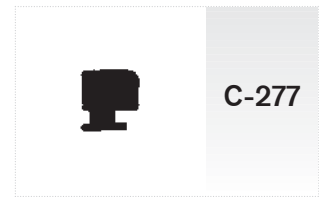
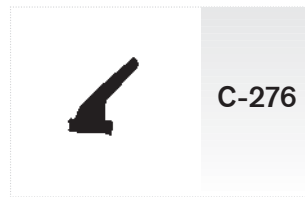
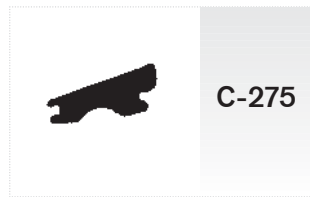
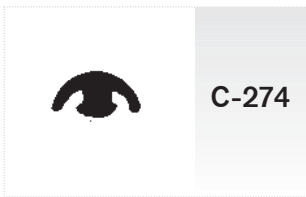
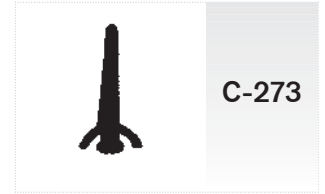
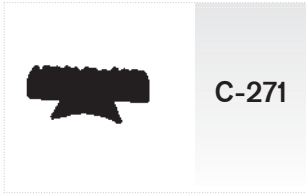
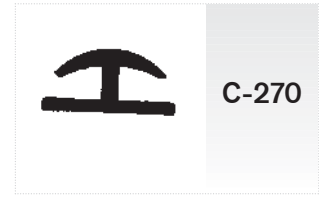
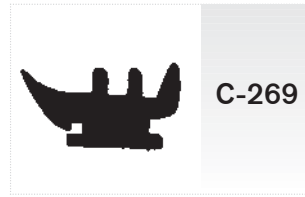
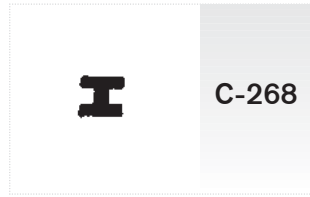

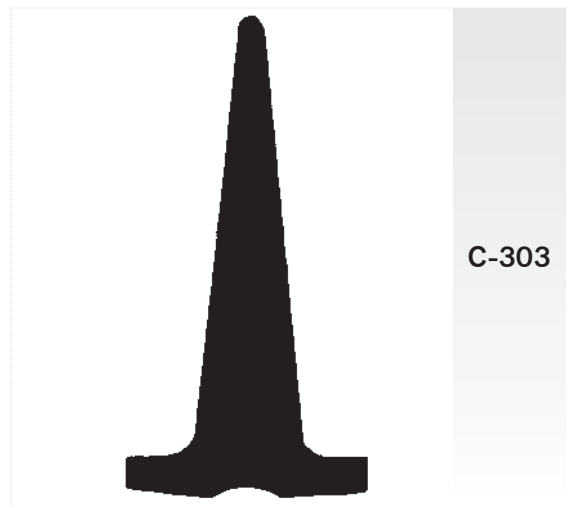
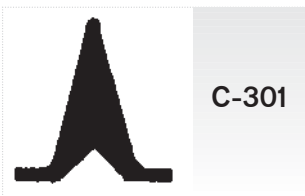
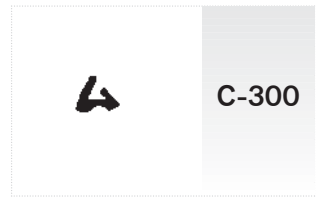
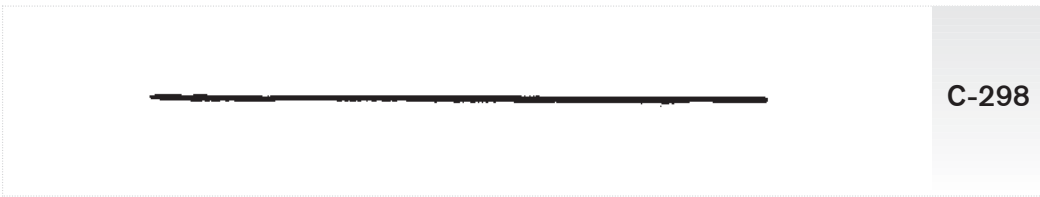
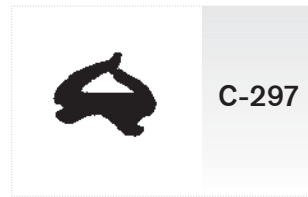
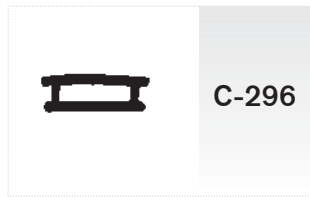
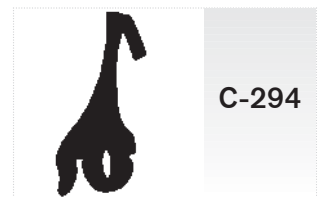
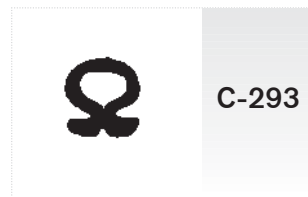
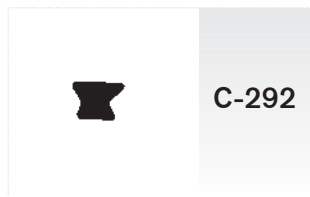
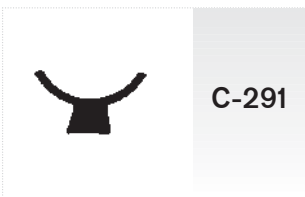
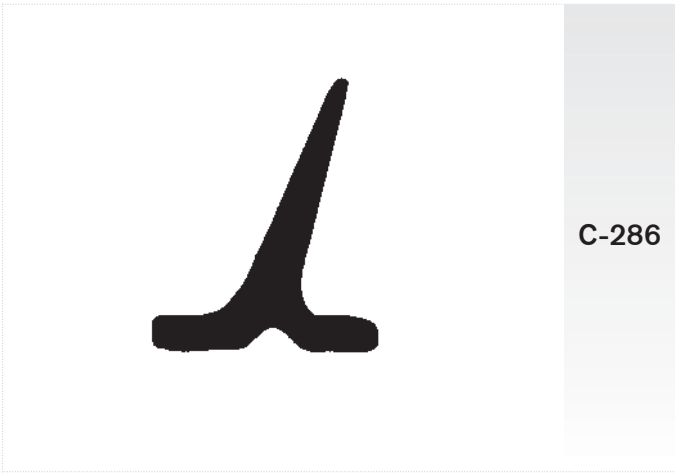





C-305



C-306



C-307



C-308



C-309



C-310



C-311



C-312



C-313



C-314



C-316



C-317



C-315



C-318



C-320

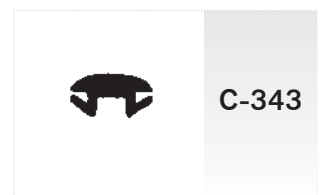
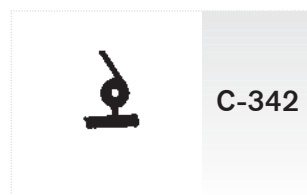
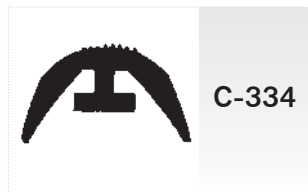
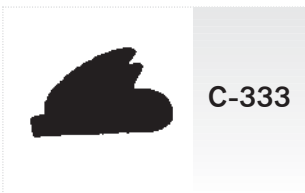
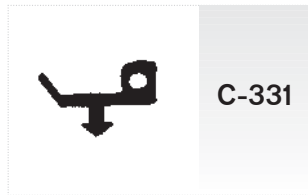
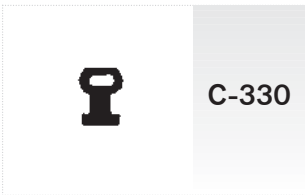
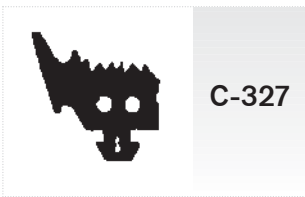
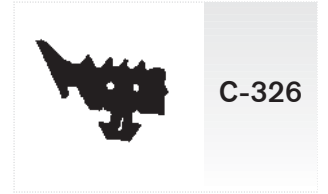
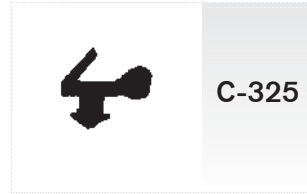
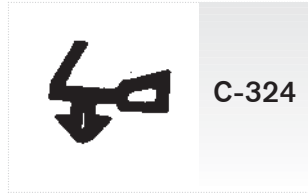
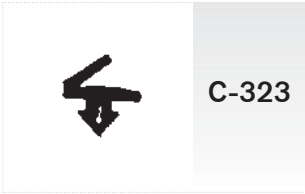
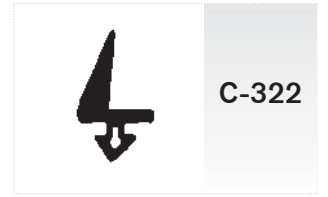
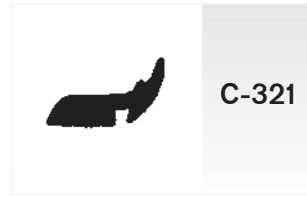

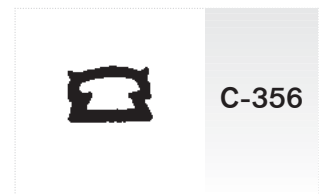
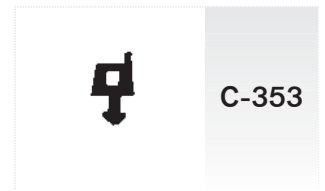
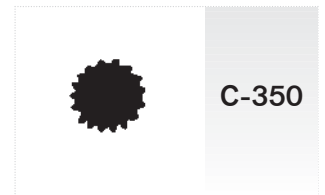
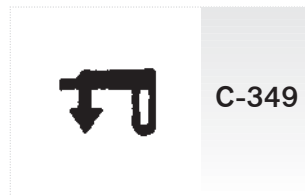
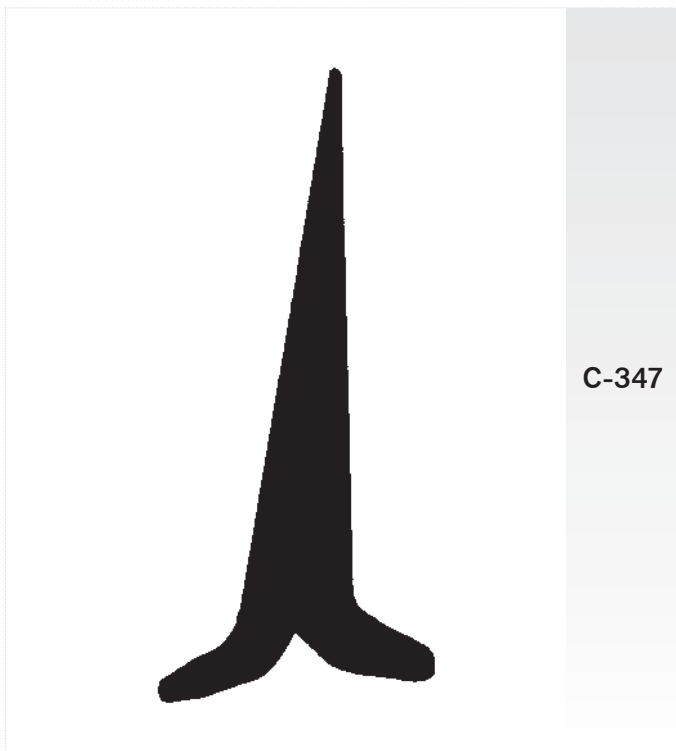
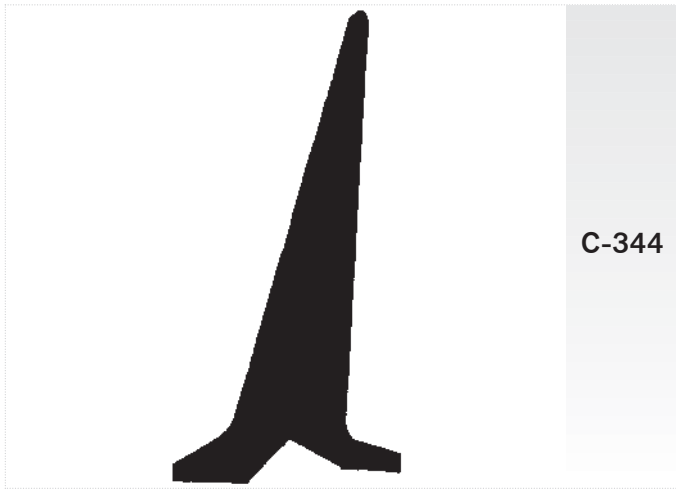



C-357

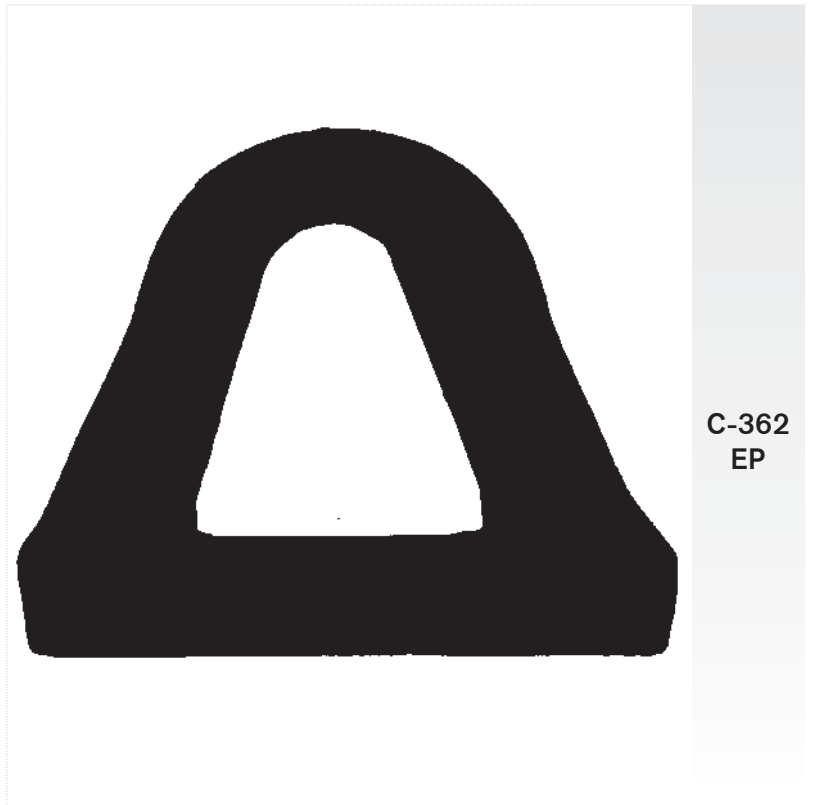

C-362  
EP

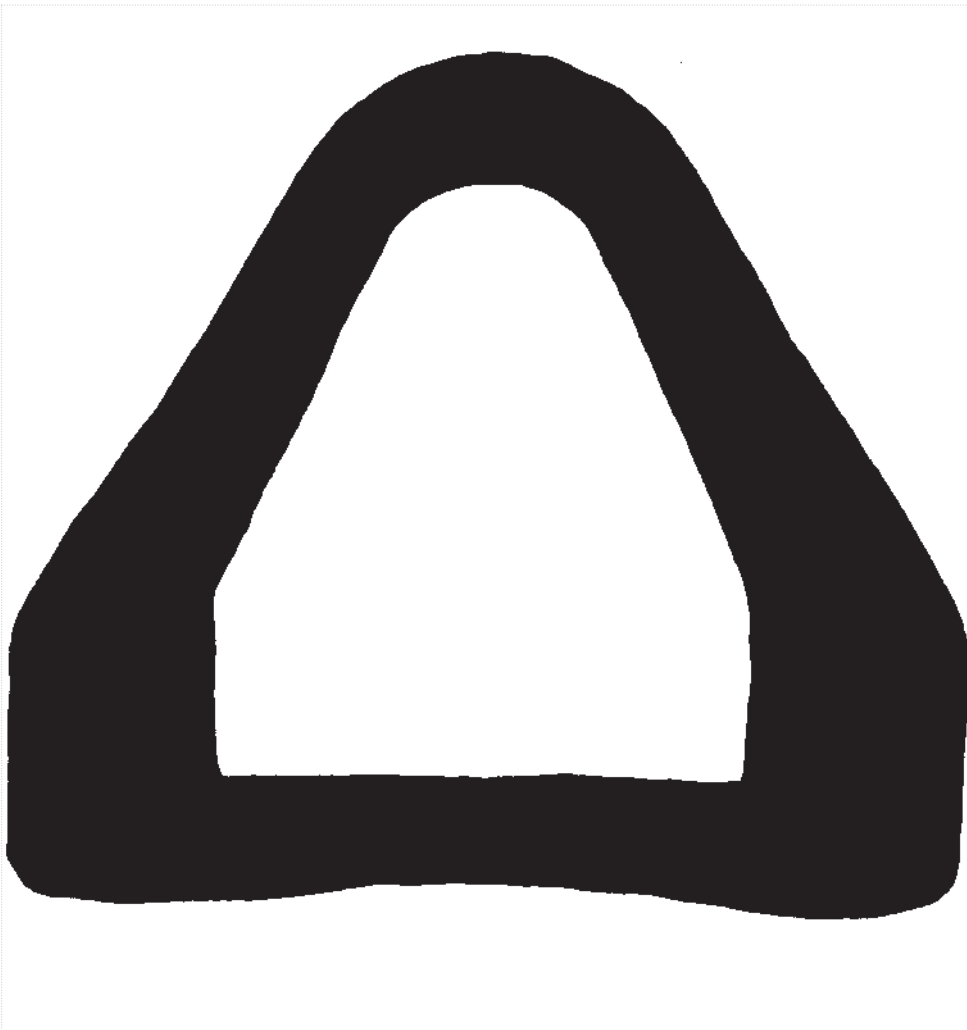

C-359  
EP

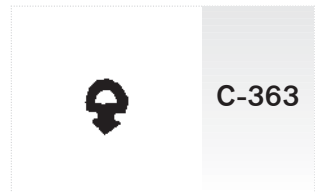

C-363

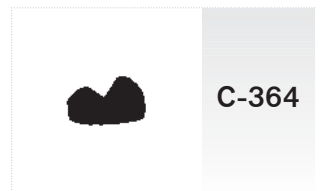

C-364



C-365



C-366



C-367



C-368



C-370



C-369



C-371



C-372



C-373



C-374



C-375



C-376



C-377  
EP



C-378



C-379



C-380



C-381



C-382



C-383



C-384



C-385



C-386



C-387



C-388





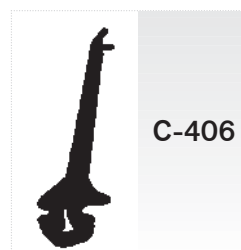
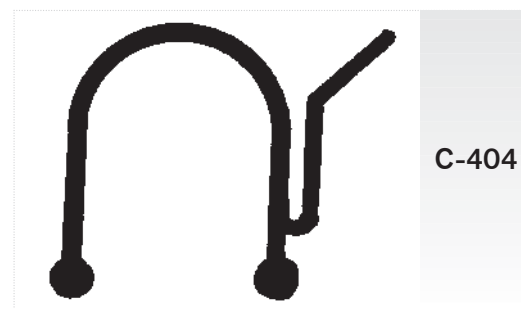
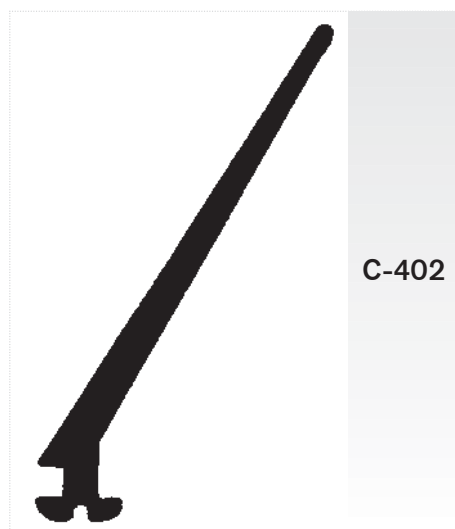
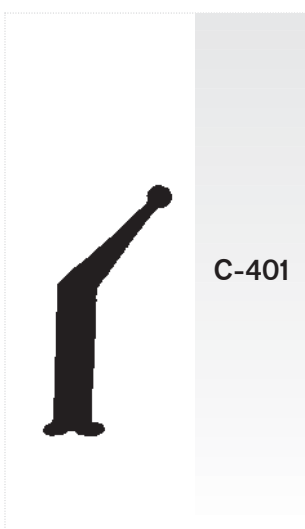
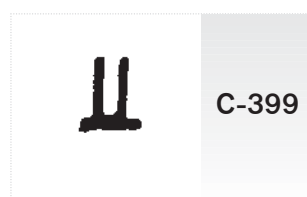
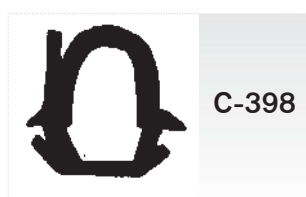
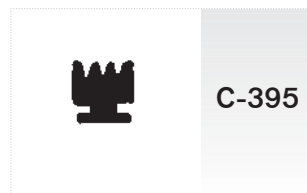
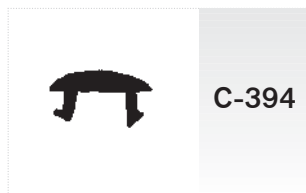
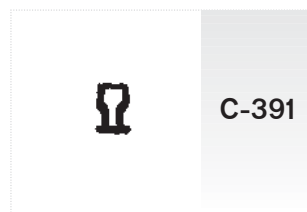

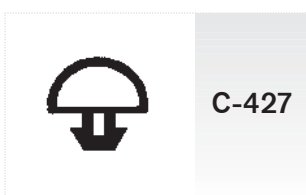
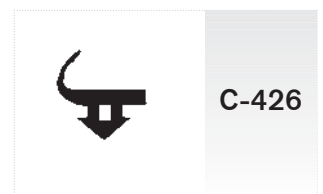
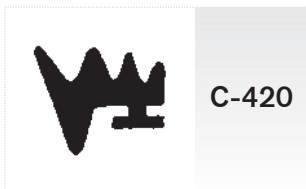
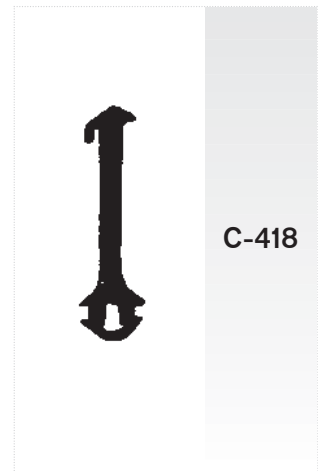
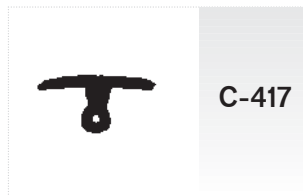
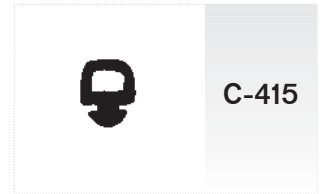
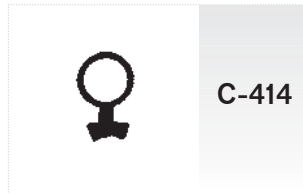
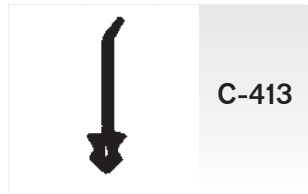
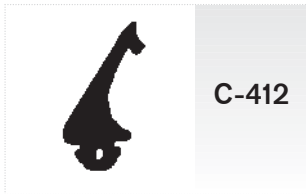

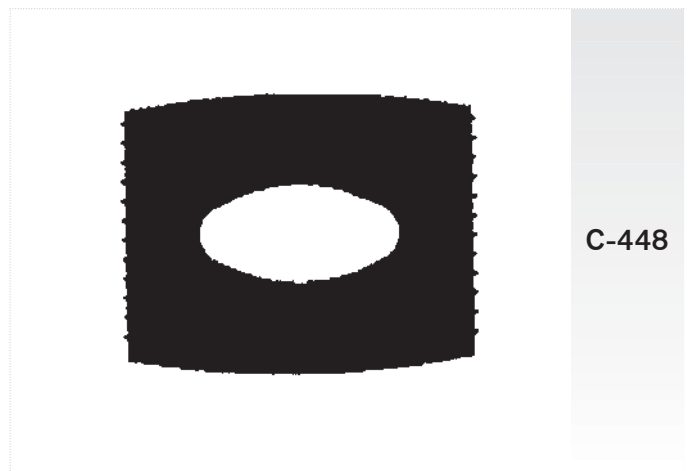
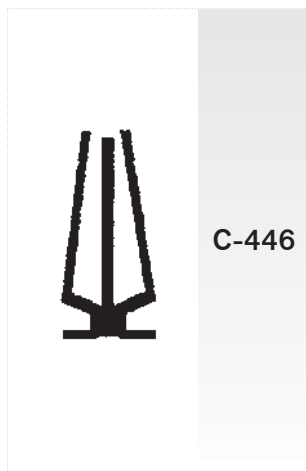
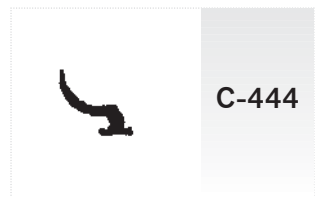
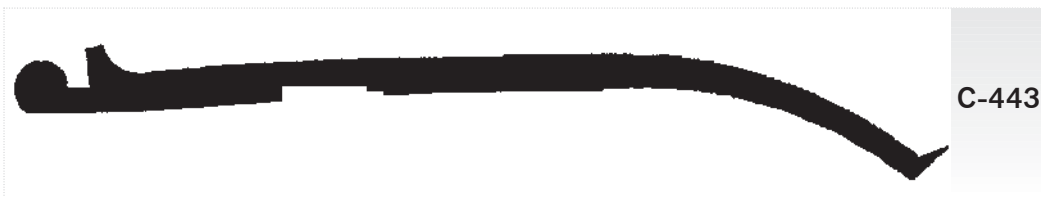
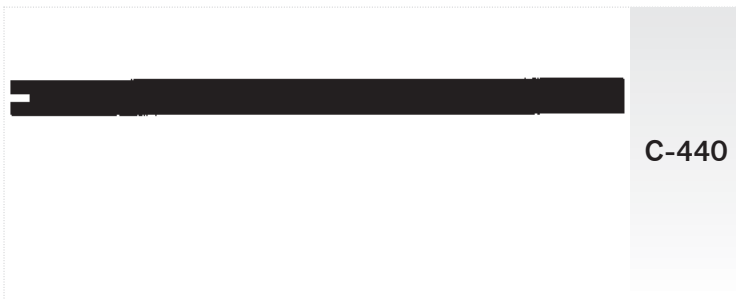
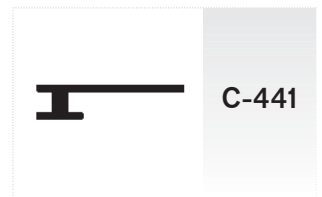
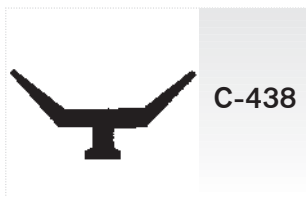
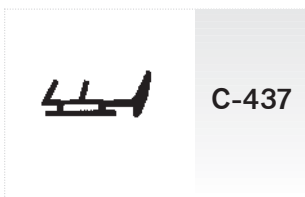
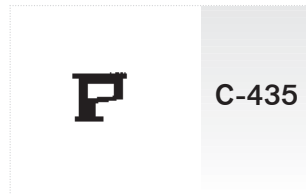
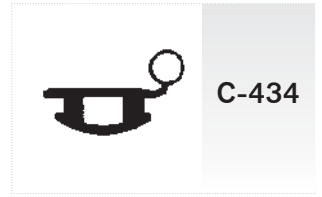
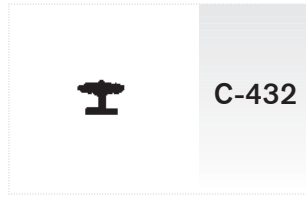
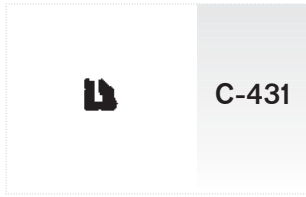
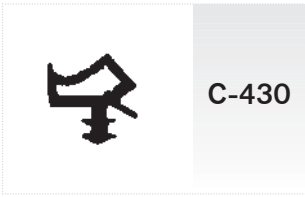





















C-389









	C-447		C-449		C-450		C-451
	C-452		C-453 EP		C-454		C-455
	C-456		C-457		C-458		C-459
	C-460		C-461		C-462		C-463
	C-464		C-465		C-466		C-467
	C-468		C-469		C-470		C-471
	C-472		C-473		C-474		C-476

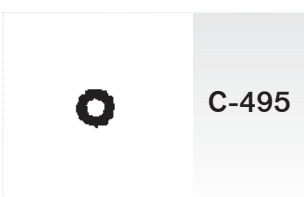
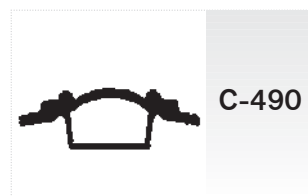
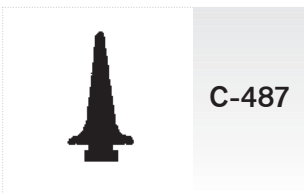
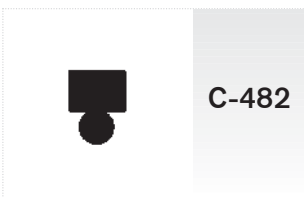
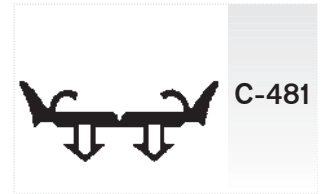
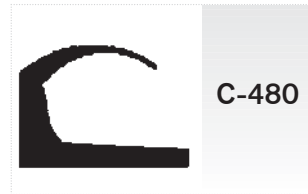
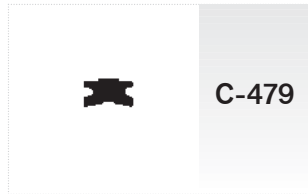
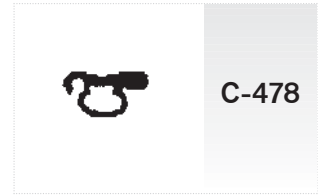
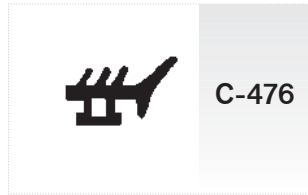
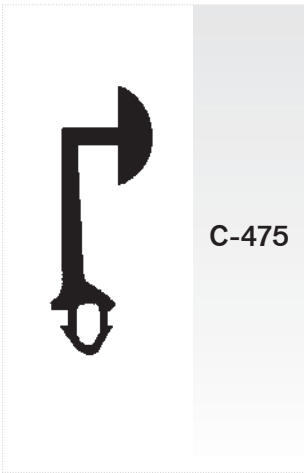



C-499



C-500

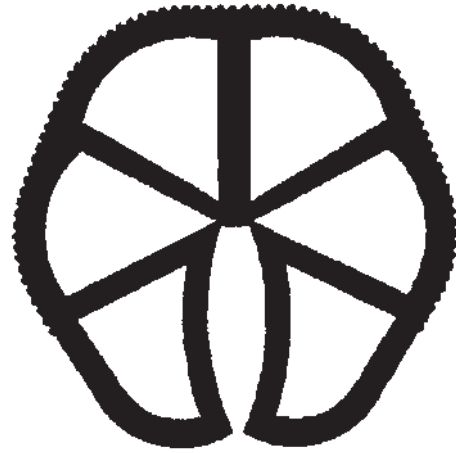

C-501



C-502



C-503



C-504



C-505



C-506  
EP



C-507



C-508



C-509



C-510



C-511



C-512



C-513



C-514



C-515



C-516



C-517



C-520



C-518



C-519



C-521

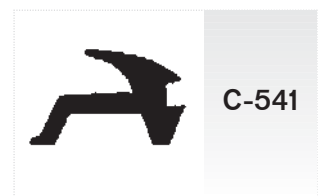
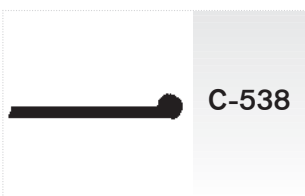
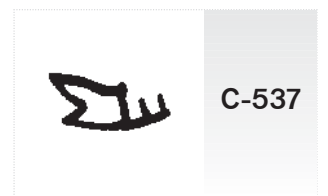
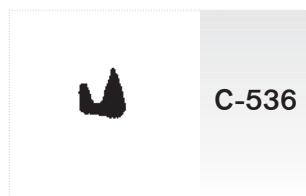
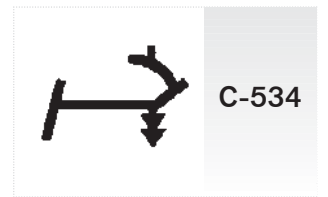
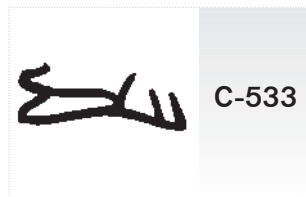
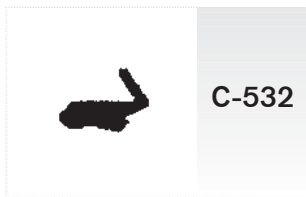
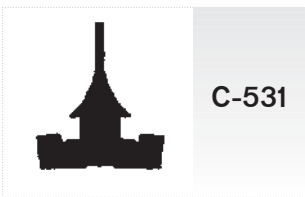
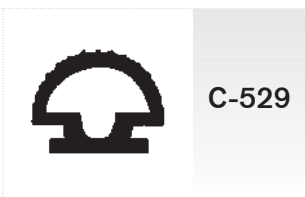
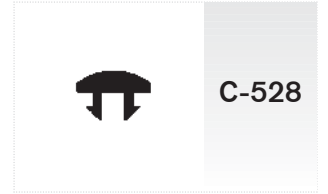
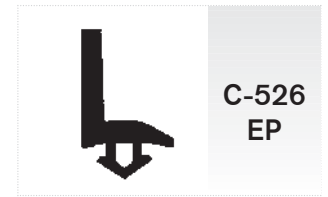
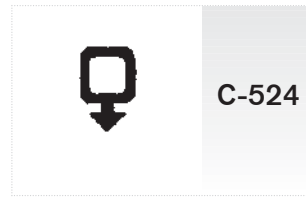
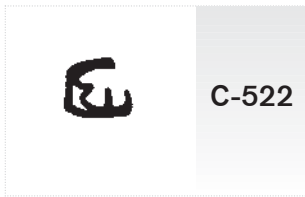

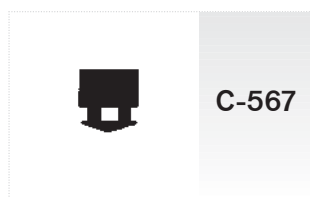
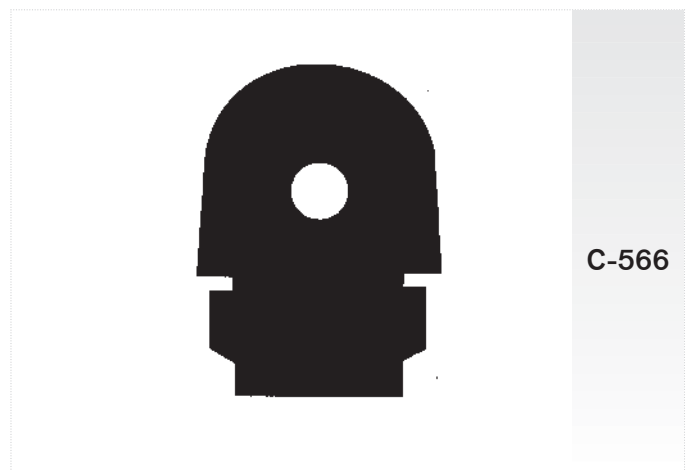
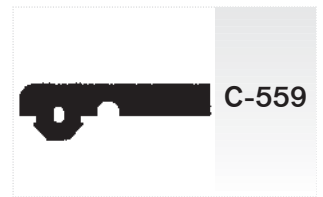
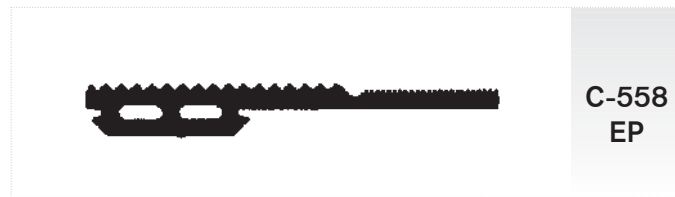
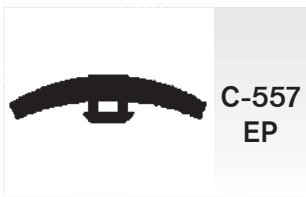
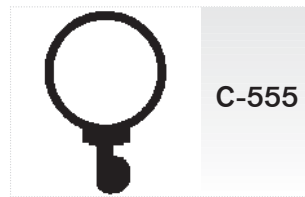
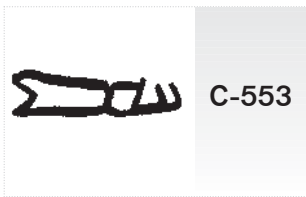
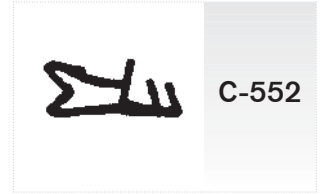
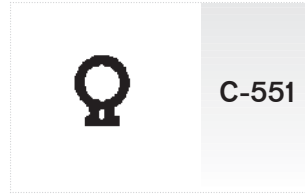

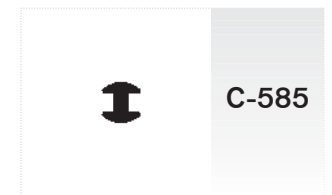
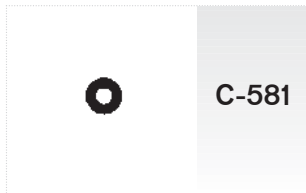
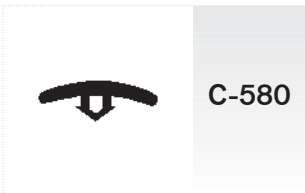
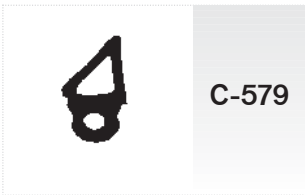
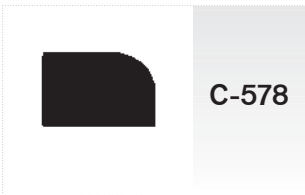
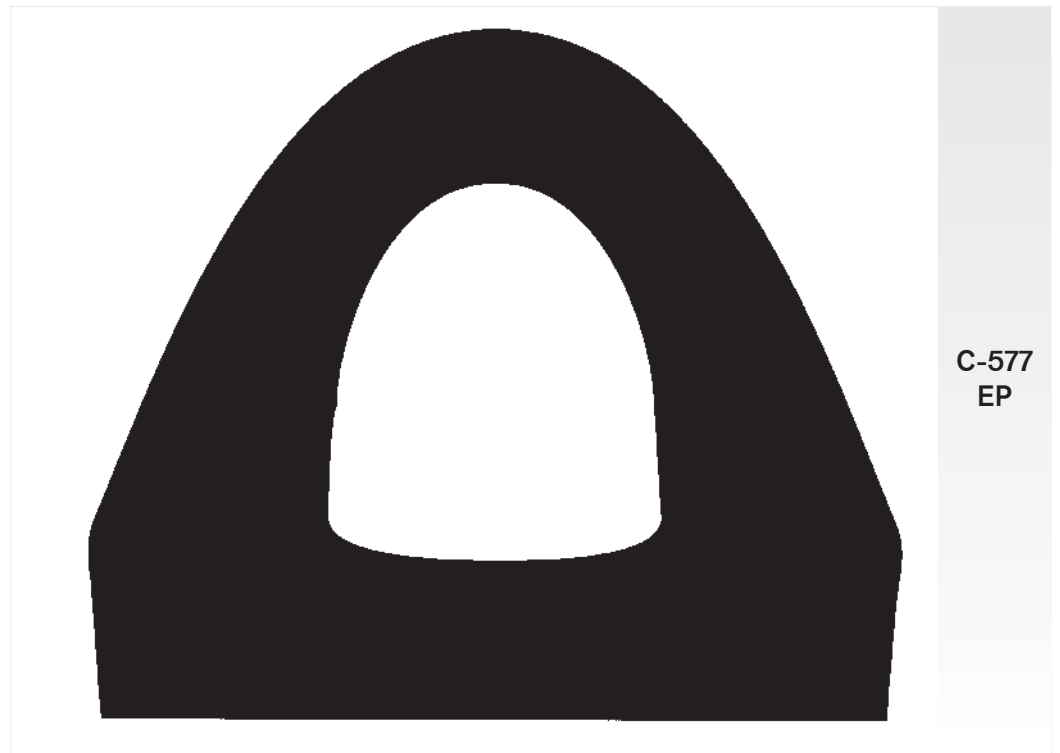
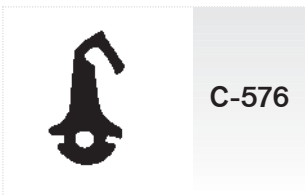
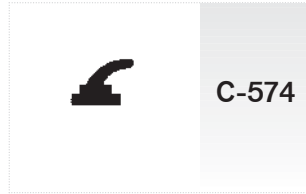
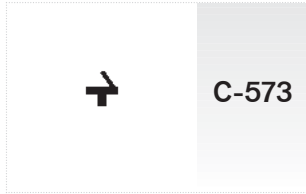
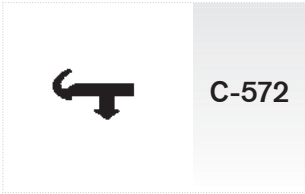
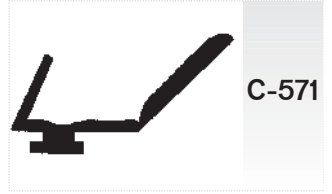
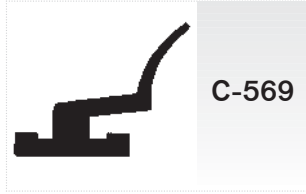

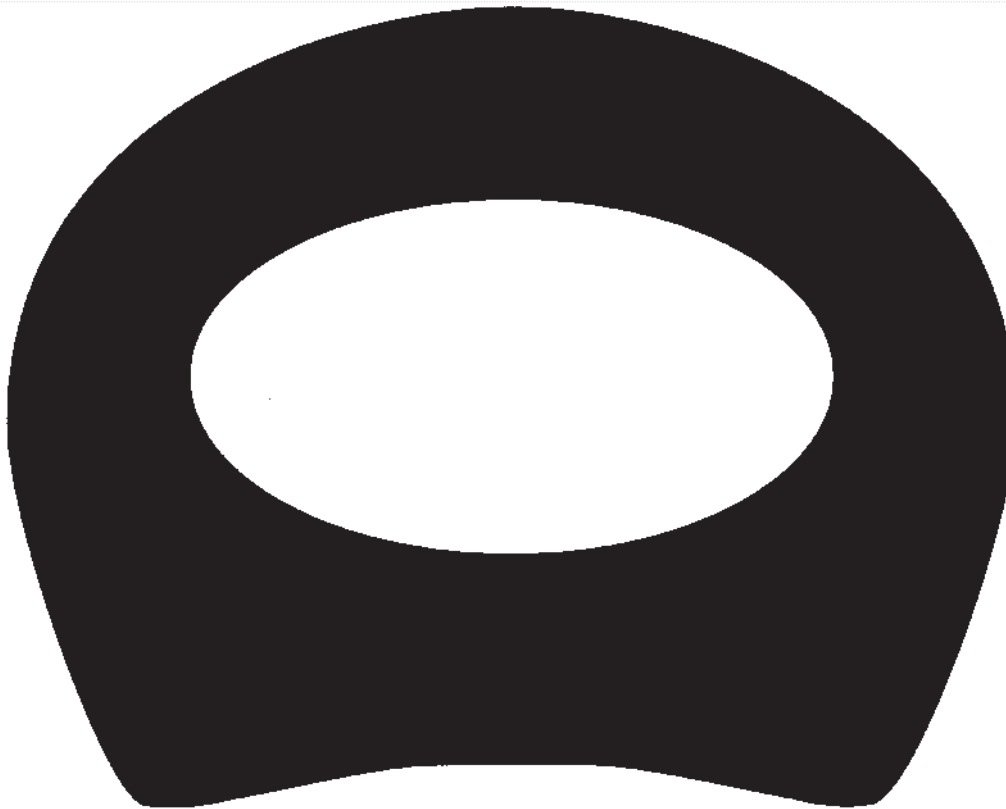

C-584  
EP



C-586



C-587



C-588



C-589



C-590



C-591



C-592



C-593



C-594



C-595



C-596



C-597

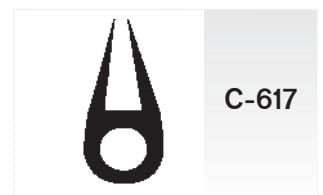
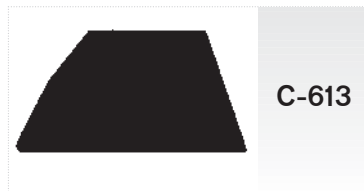
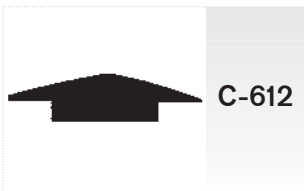
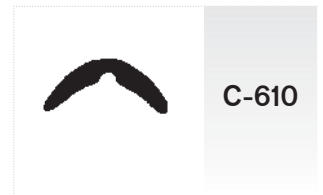
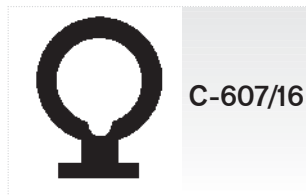
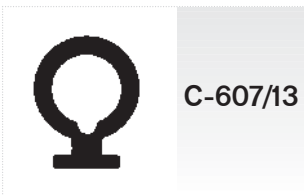
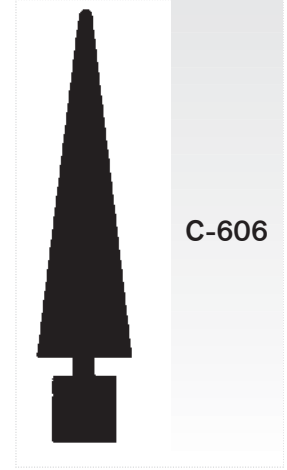
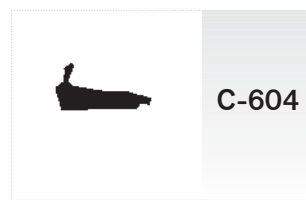
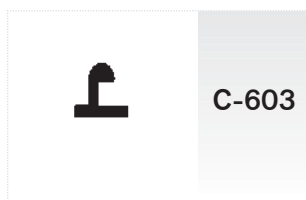
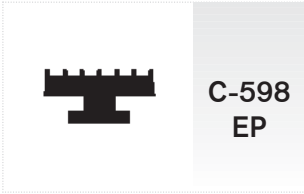



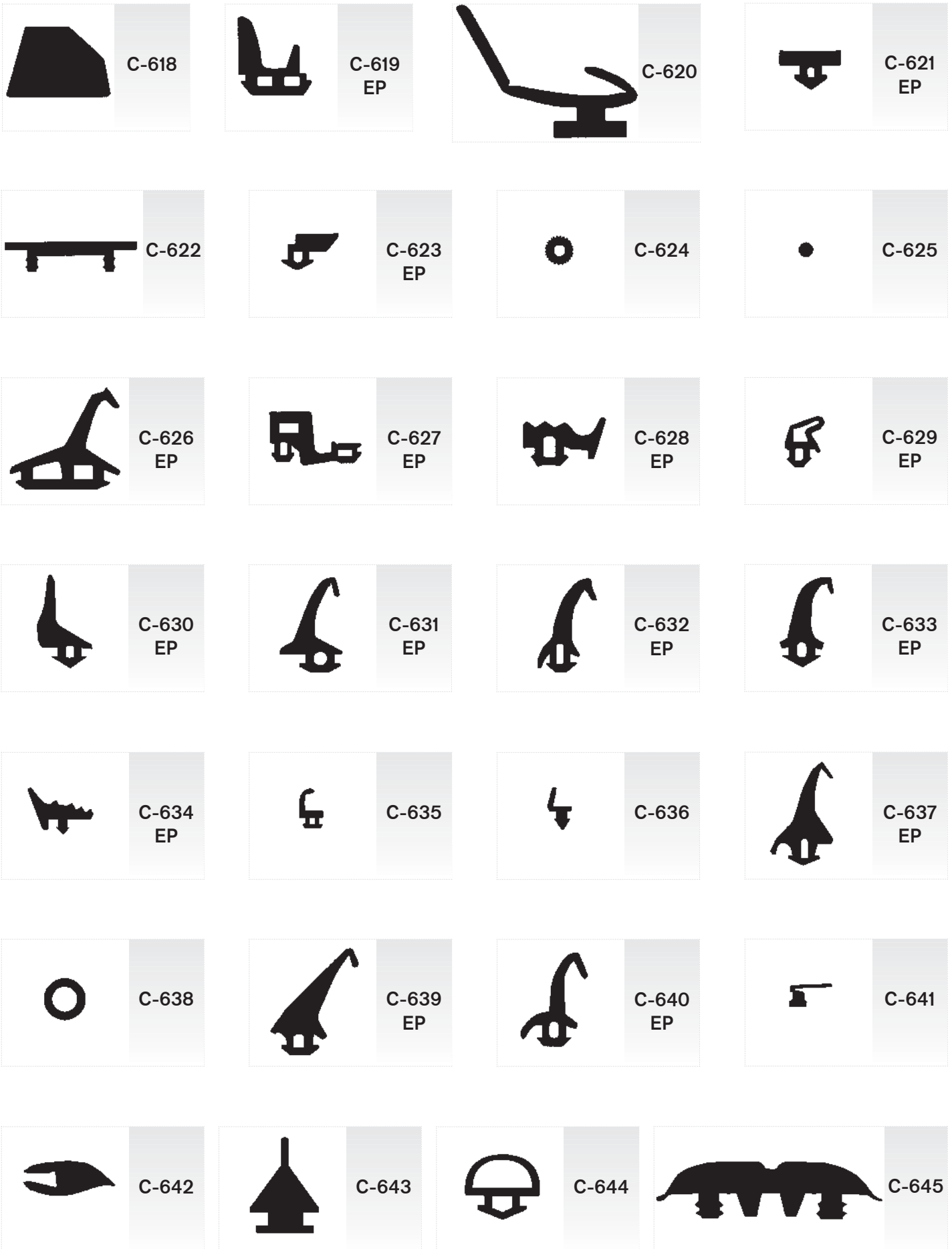

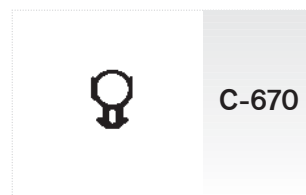
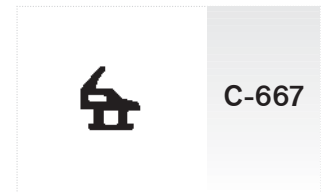
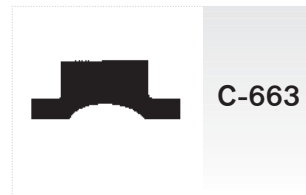
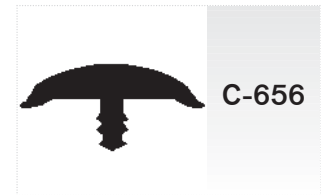
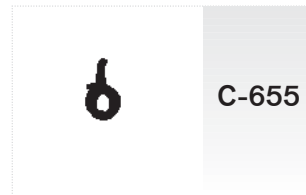
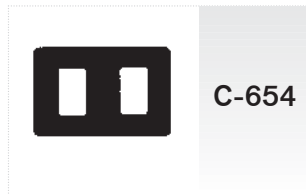
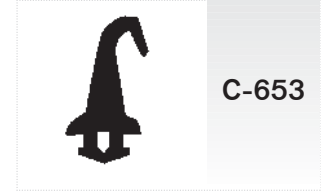
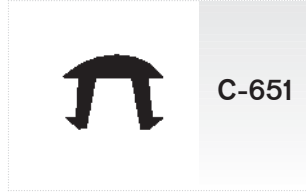
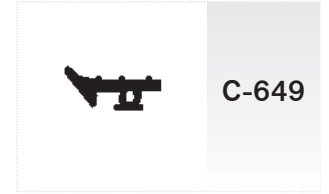
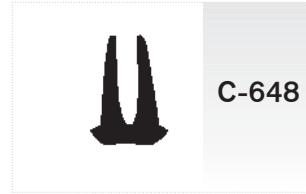
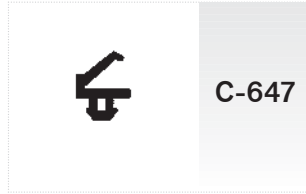

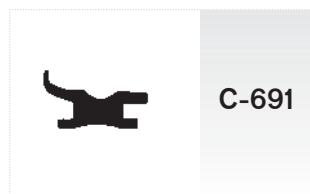
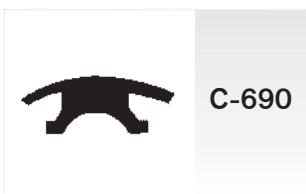
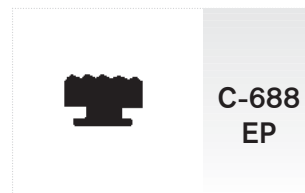
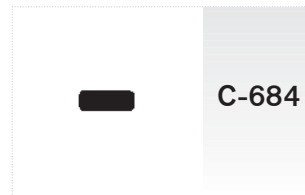
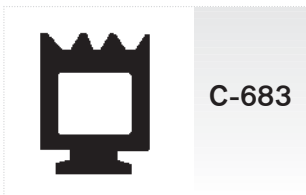
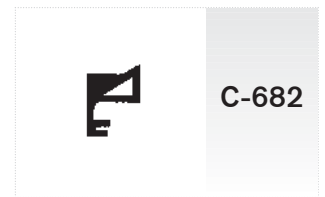
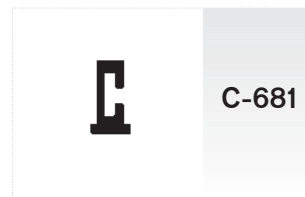
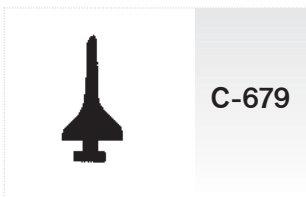
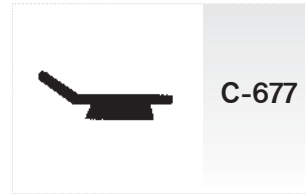
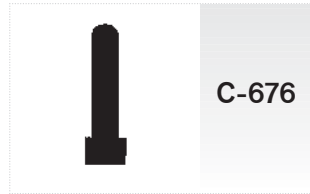
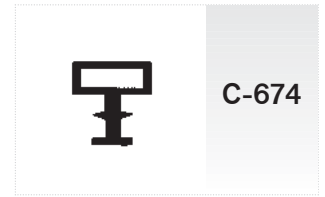
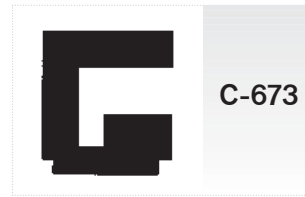

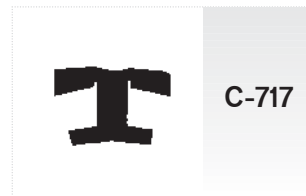
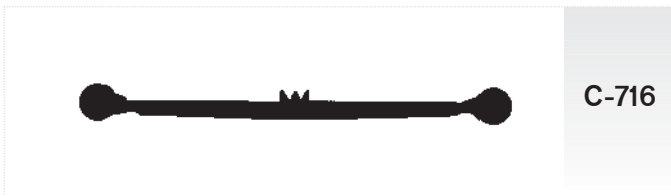
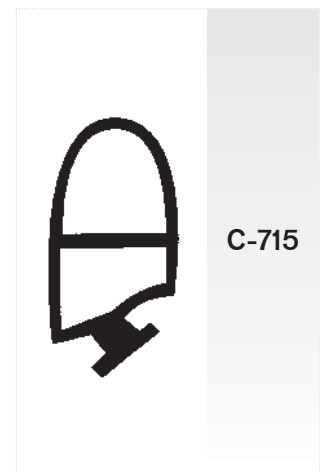
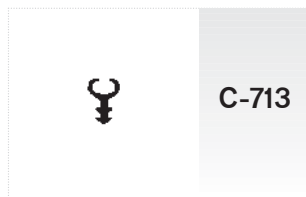
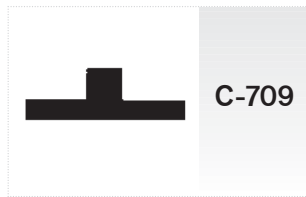
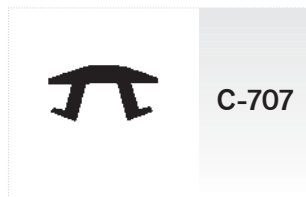
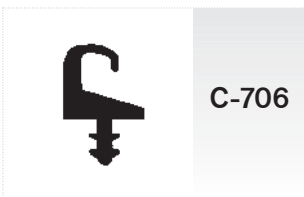
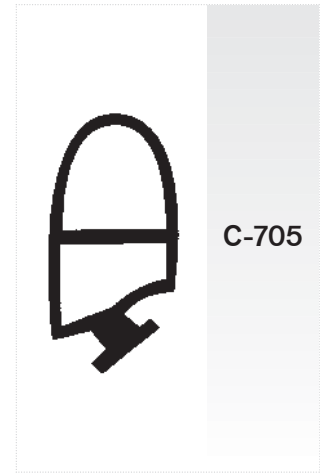
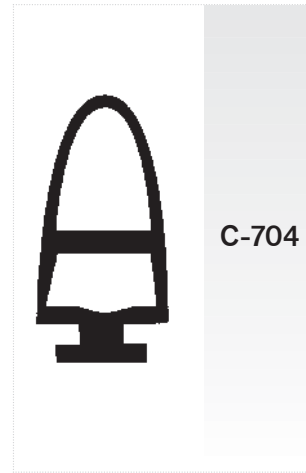
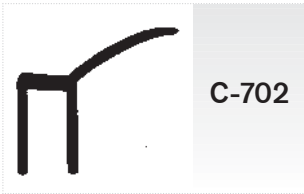
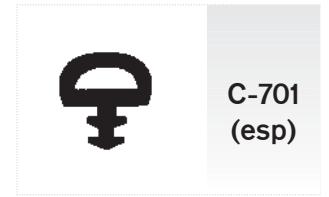
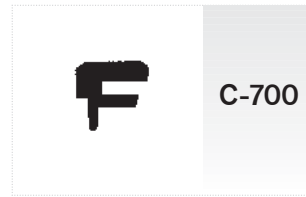
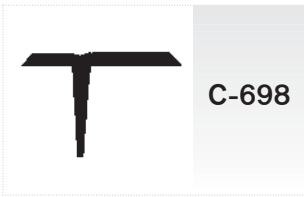

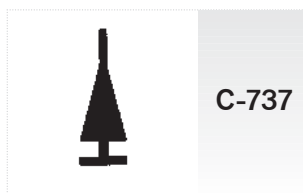
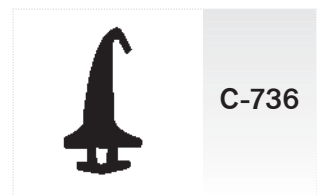
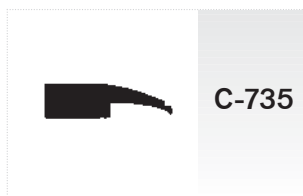
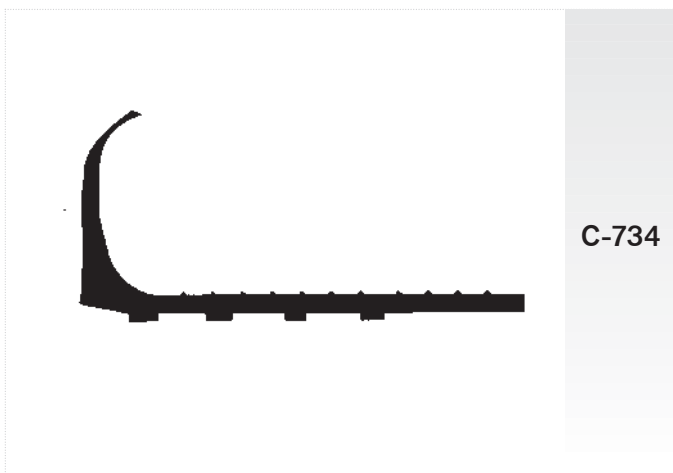
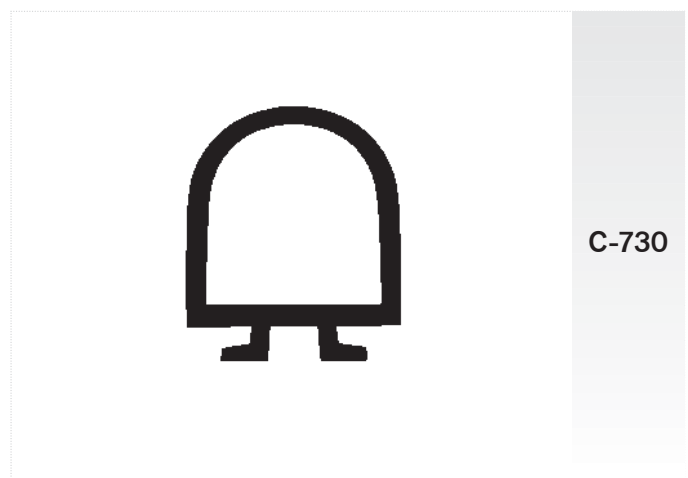
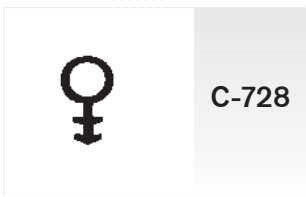
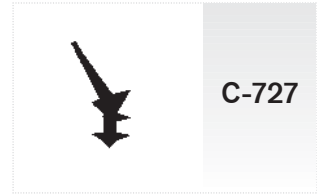
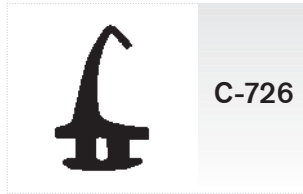
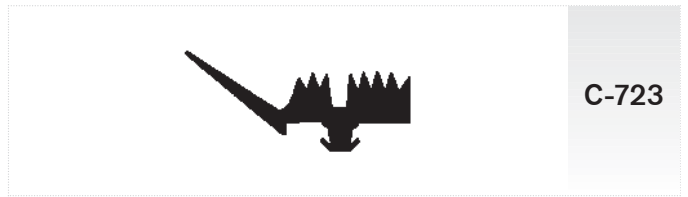
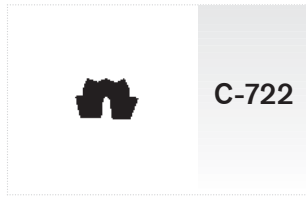
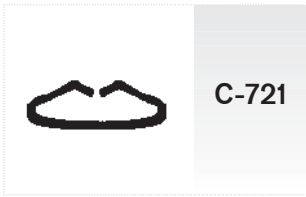

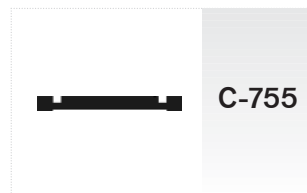
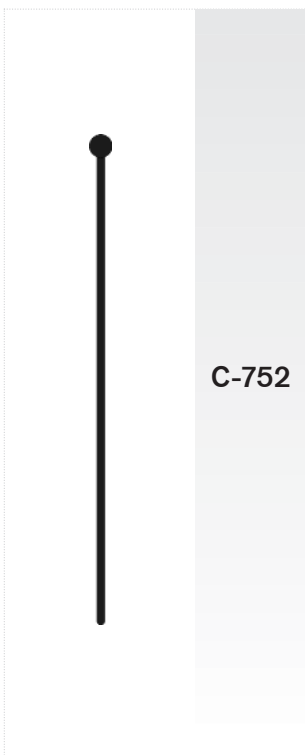
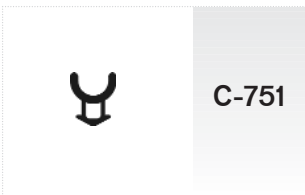
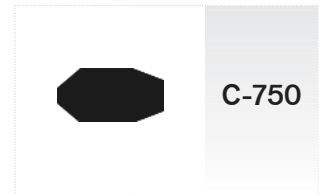
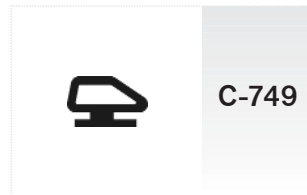
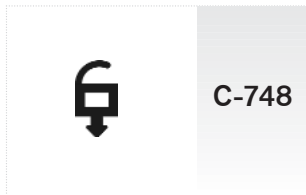
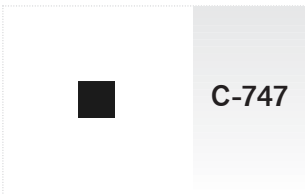
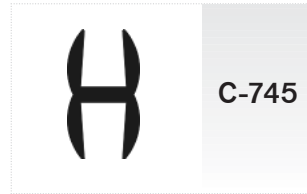
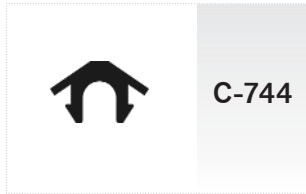
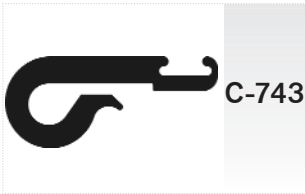
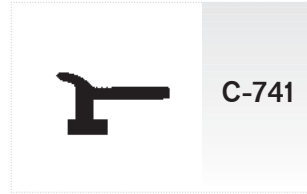
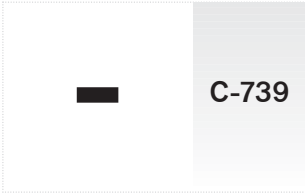



C-762



C-763



C-764



C-765



C-766



C-767



C-768



C-770



C-769



C-771  
EP



C-772



C-773



C-776



C-774



C-775  
EP

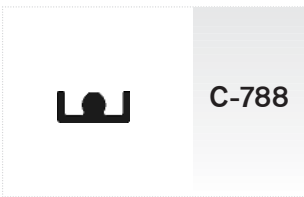
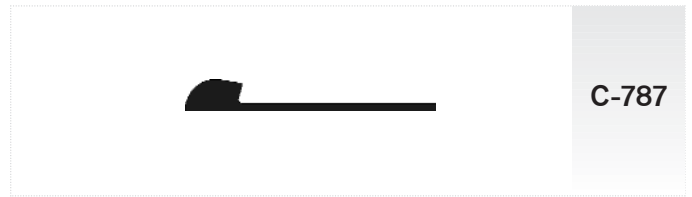
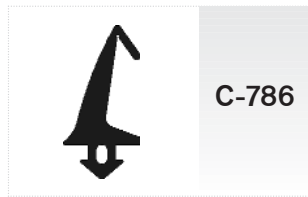
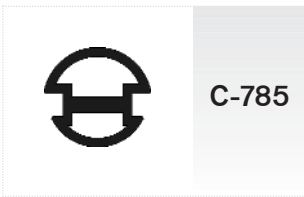
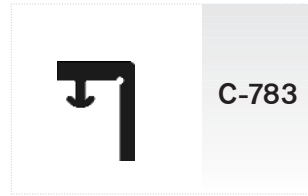
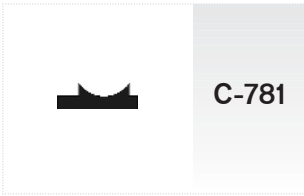
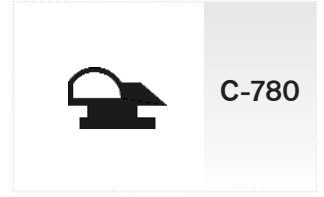
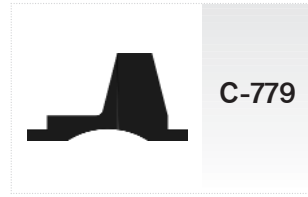





C-802



C-803



C-804



C-805



C-806



C-807



C-808



C-809



C-810



C-811



C-812



C-813



C-814



C-815



C-816



C-817



C-818



C-819



C-820



C-821  
EP



C-822



C-823



C-824  
EP



C-825  
EP

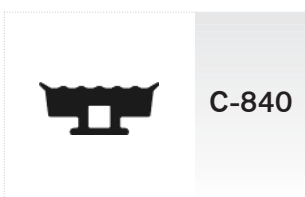
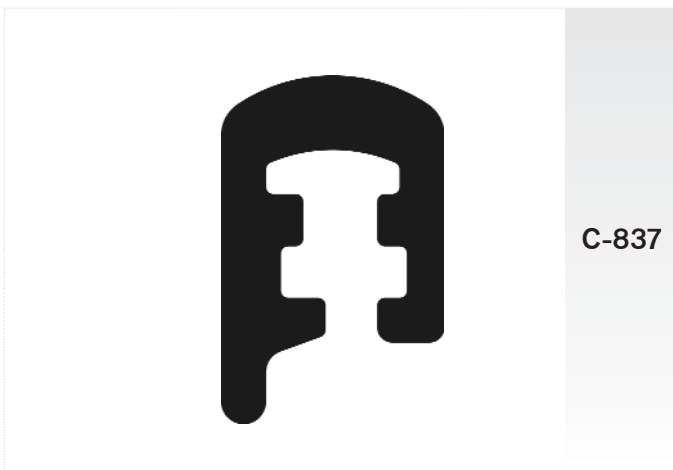
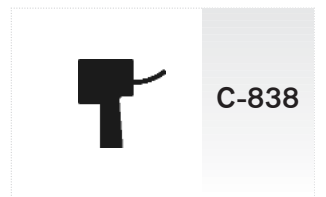
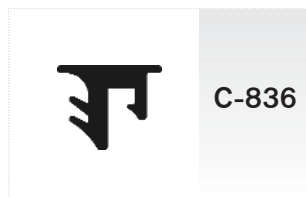
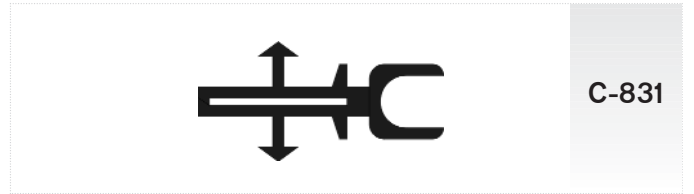
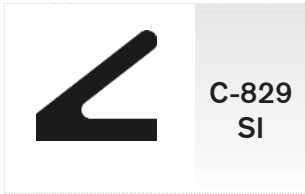
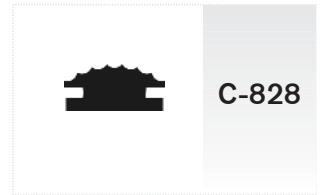
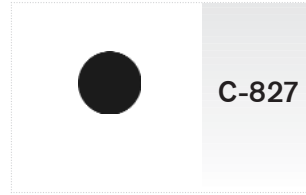
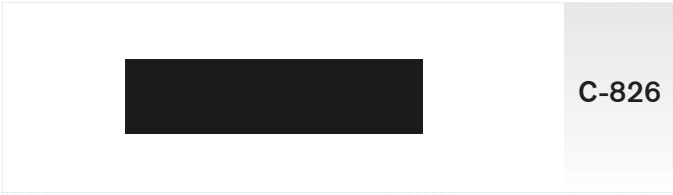

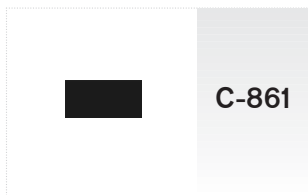
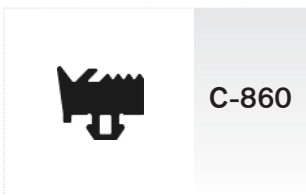
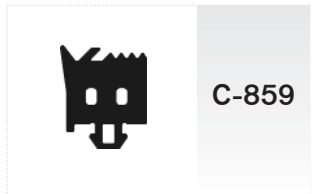
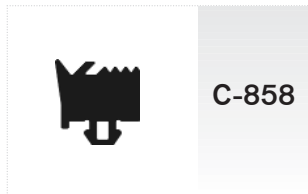
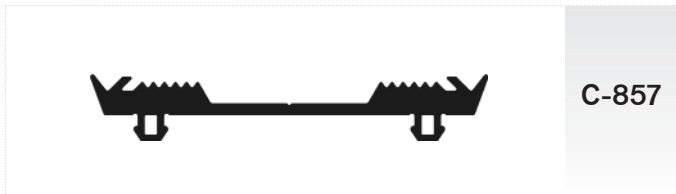
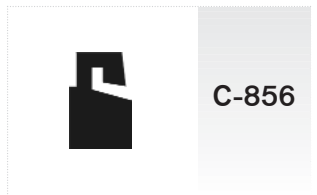
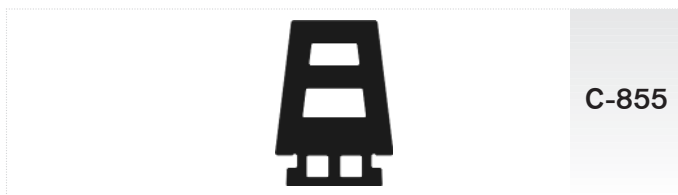
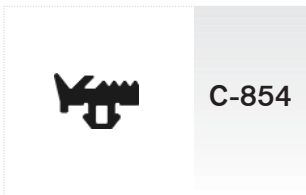
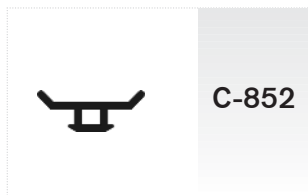
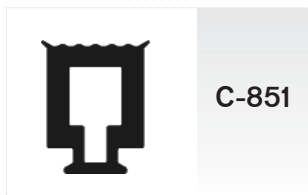
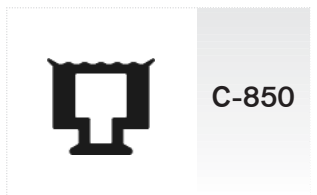
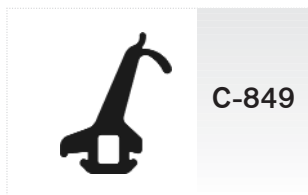
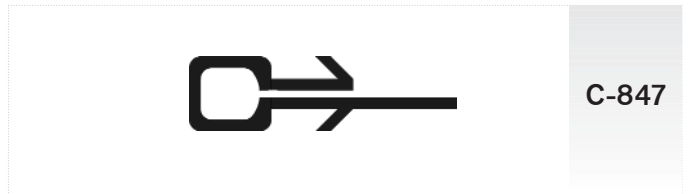
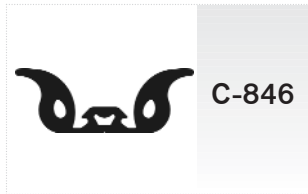
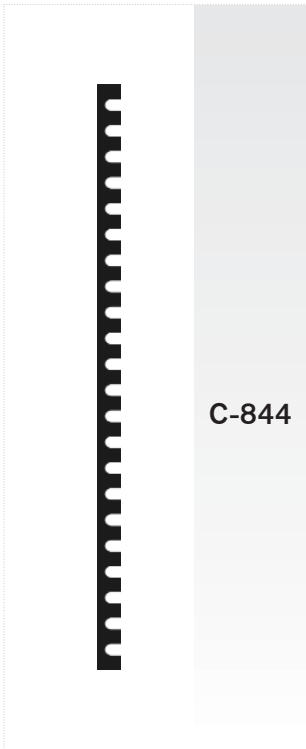
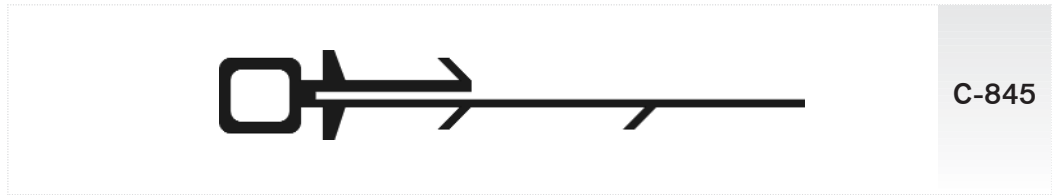
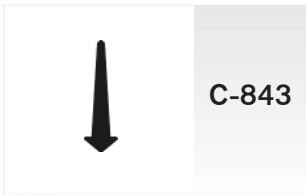

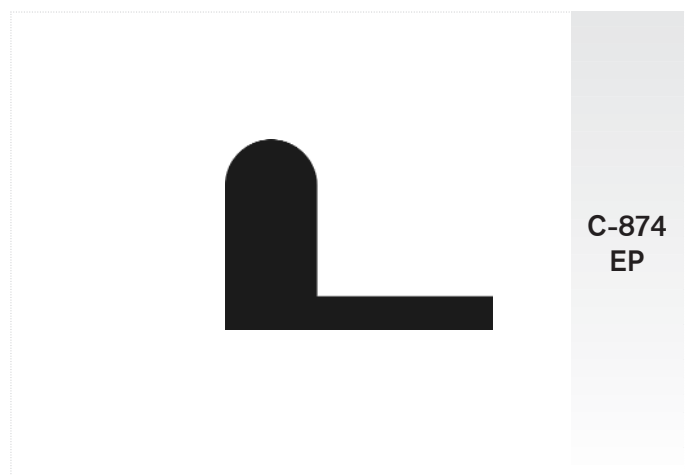
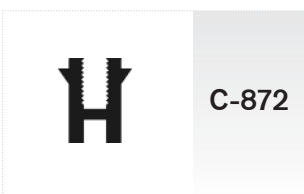
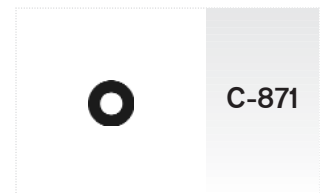
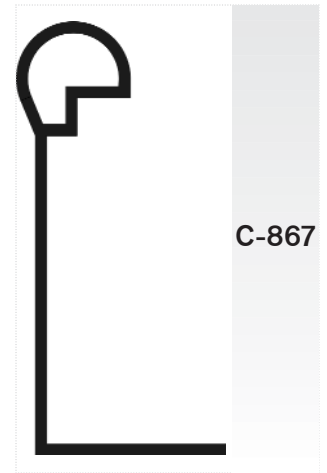
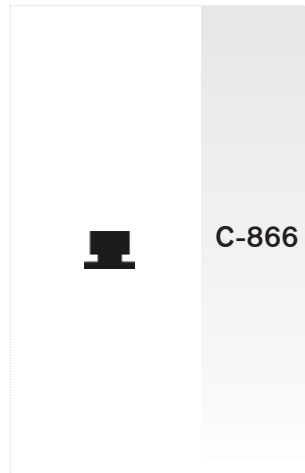
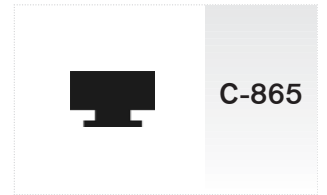
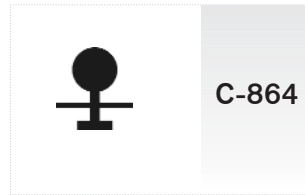
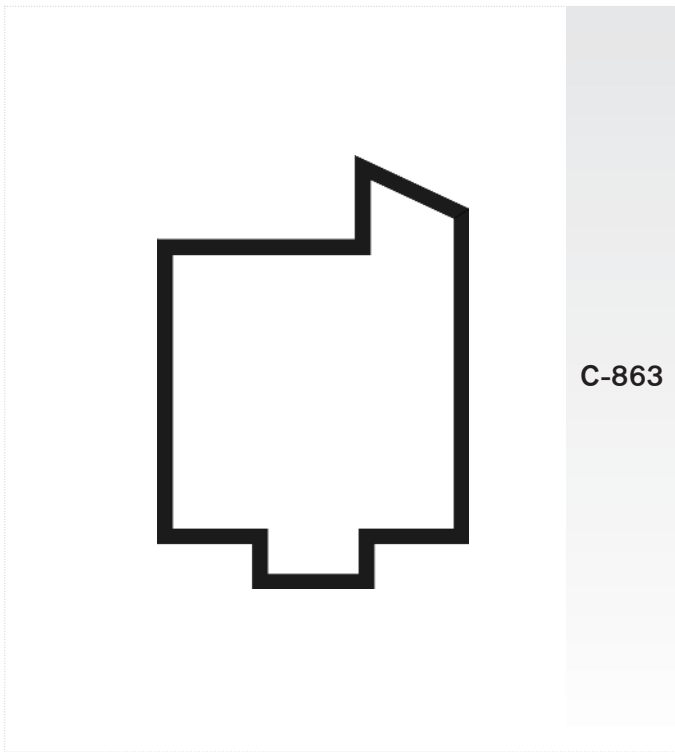

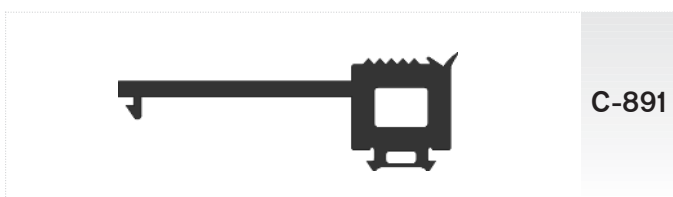
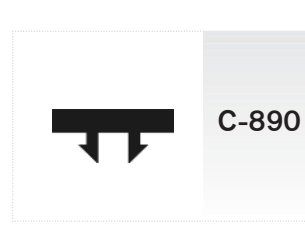
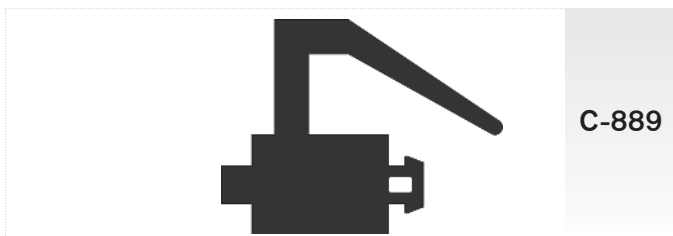
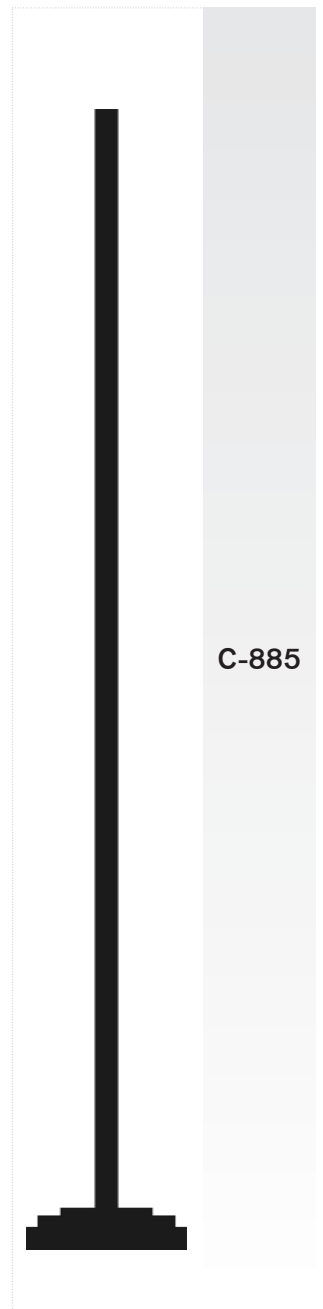
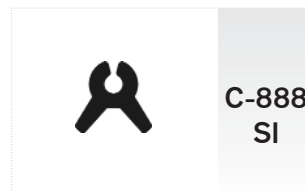
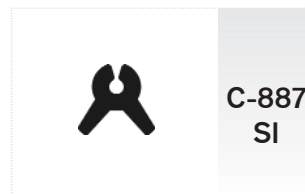
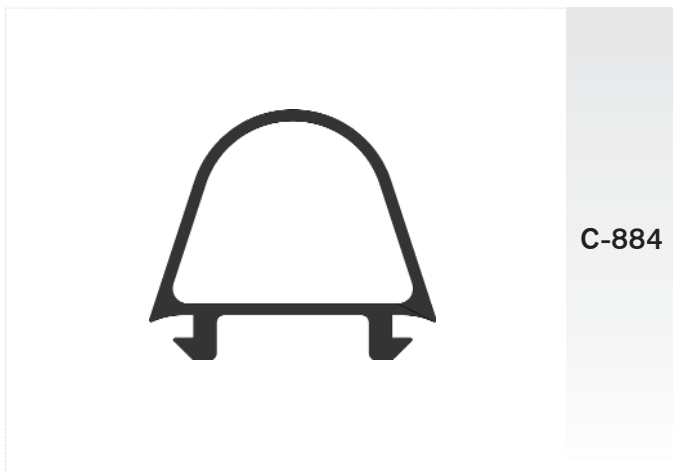
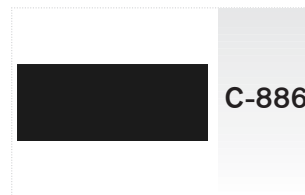
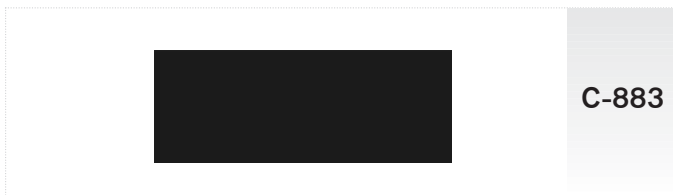
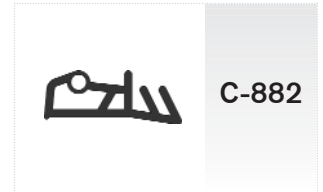
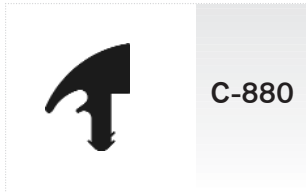
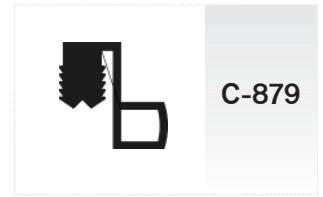
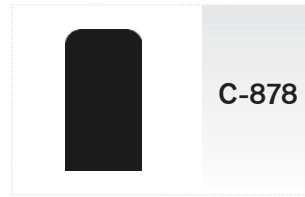

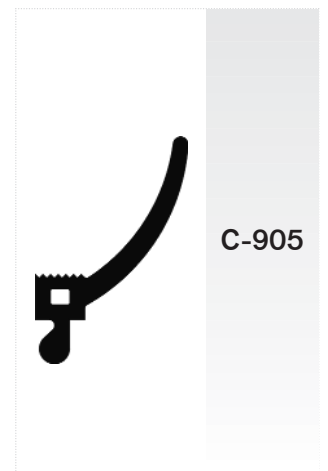
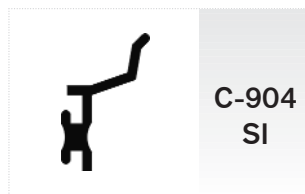
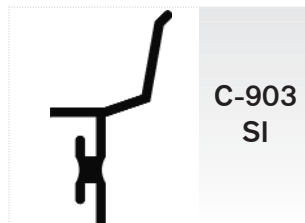
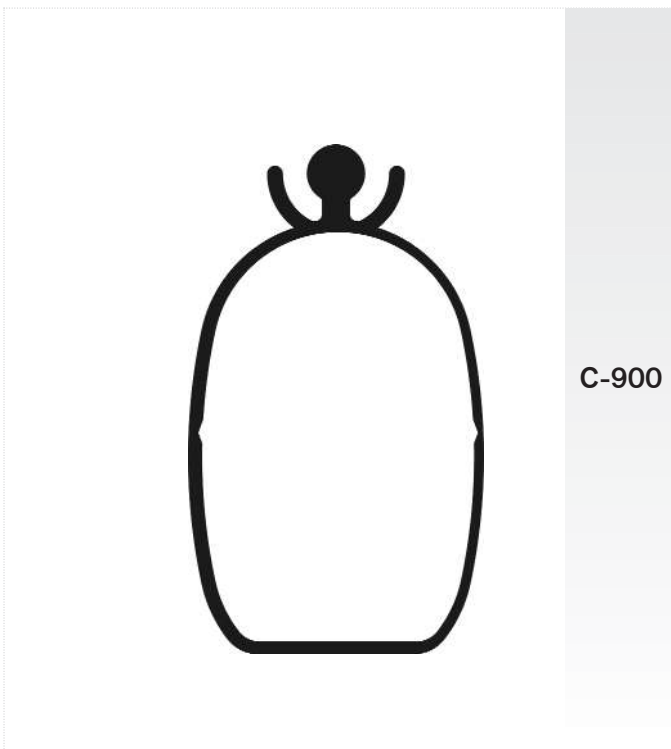
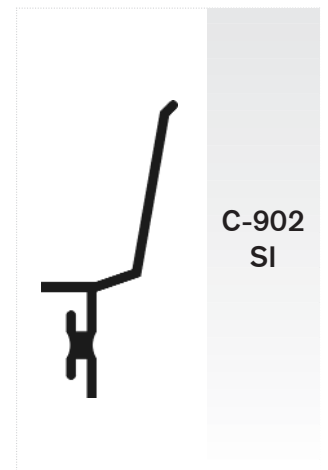
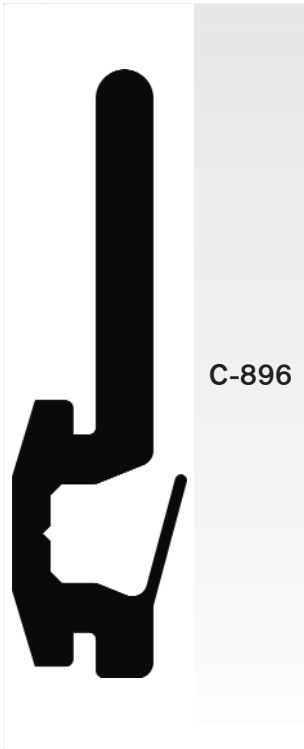

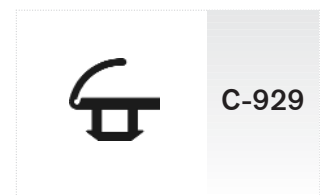
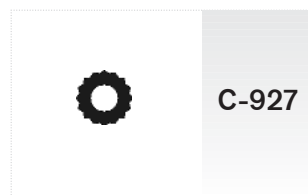
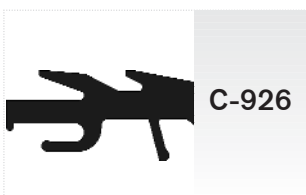
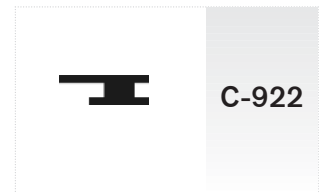
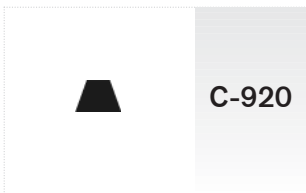
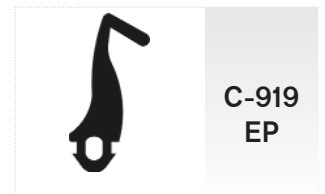
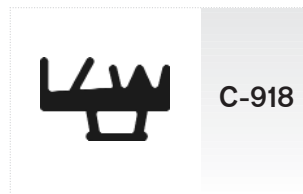
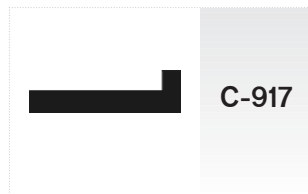
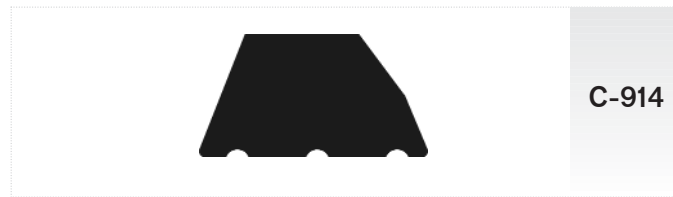
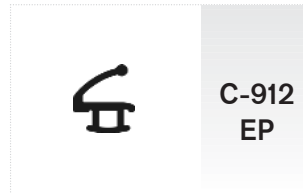
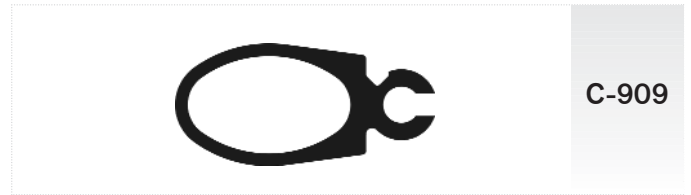
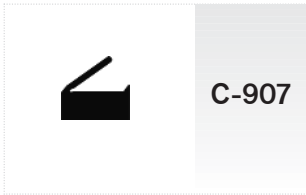

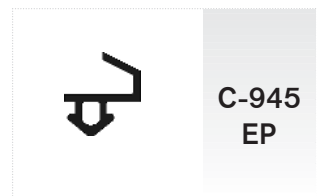
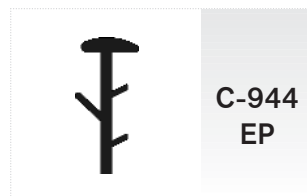
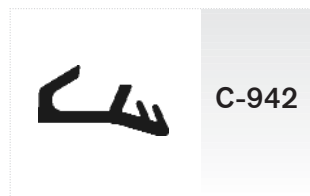
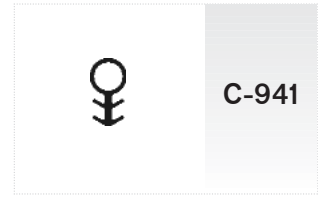
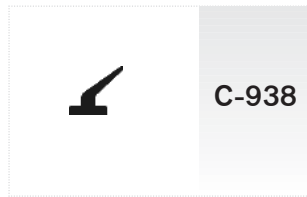
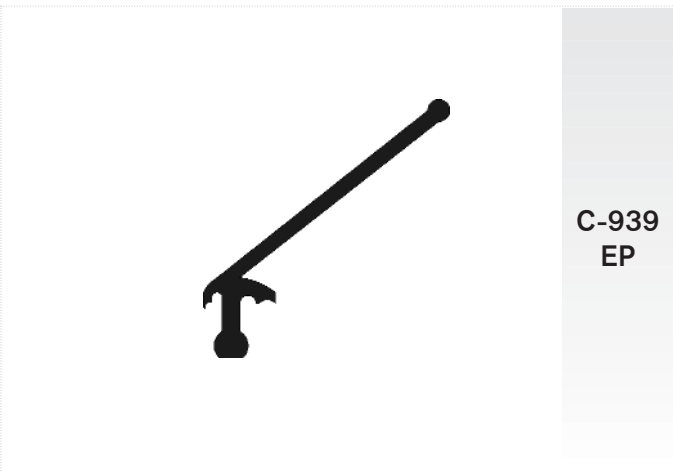
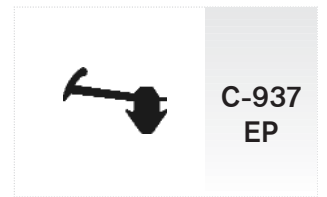
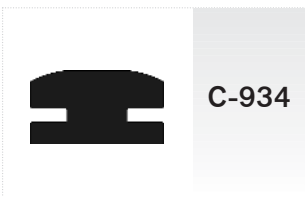
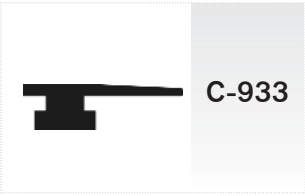
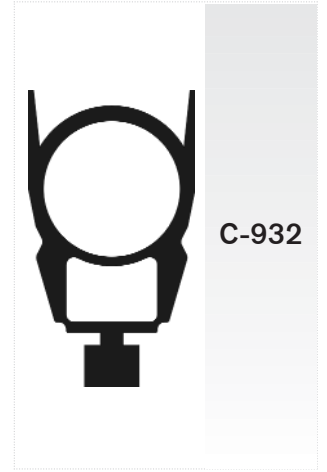
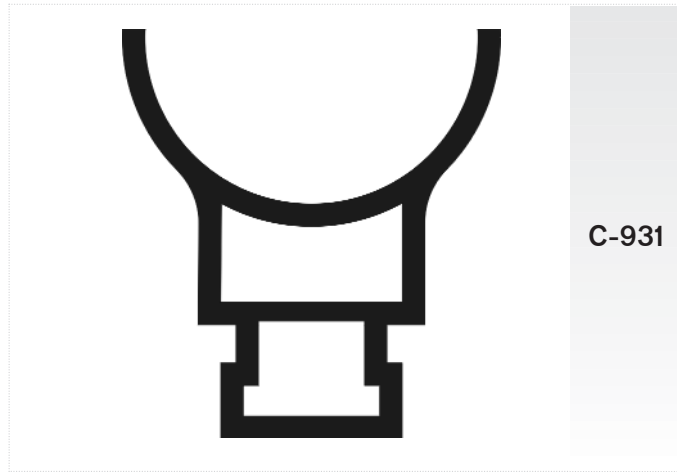



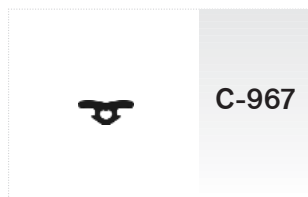
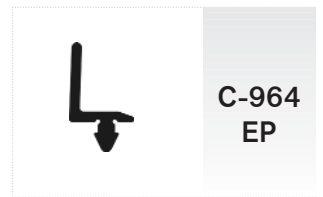
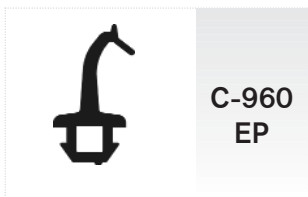
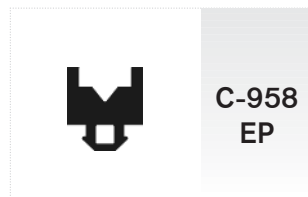
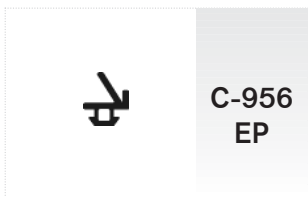
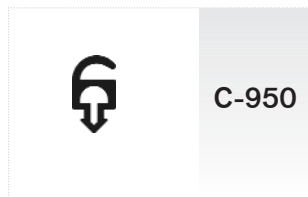
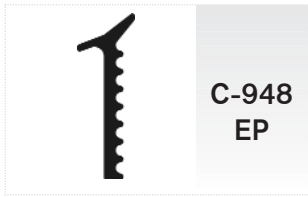



**Desde 1980 traspasando fronteras**  
**Since 1980 crossing frontiers**



[www.exterplas.com](http://www.exterplas.com)  
[exterplas@exterplas.com](mailto:exterplas@exterplas.com)



**Extrusionados Termoplásticos, S.A.**  
Ctra. De la Roca Km. 12,5  
Apartado de correos 248  
08105 Sant Fost de Campsentelles (Barcelona) - SPAIN  
Tel. +34 935 79 78 20 / +34 935 70 60 20 Fax +34 935 70 29 12